

Position and Safety Switches



	Price groups PG 41K, 42A	
12/2	Introduction	
	SIRIUS 3SE5 mechanical position switches	
12/4	General data	12/86 General data
12/13	3SE5, plastic enclosures - Enclosure width 31 mm acc. to EN 50047	12/88 Plastic enclosures
12/18	- Enclosure width 40 mm acc. to EN 50041	12/92 Metal enclosures <u>With separate actuator</u>
12/22	- Enclosure width 50 mm	12/94 General data
12/26	- Ambient temperature to -40 °C	12/95 Plastic enclosures
12/30	3SE5, metal enclosures - Enclosure width 31 mm acc. to EN 50047	12/96 Metal enclosures
12/34	- Enclosure width 40 mm acc. to EN 50041	12/97 Accessories <u>With solenoid interlocking</u>
12/38	- Enclosure width 56 mm	12/98 General data
12/42	- Enclosure width 56 mm, XL	12/99 Plastic enclosures
12/45	- Ambient temperature to -40 °C	12/100 Metal enclosures <u>Hinge switches</u>
12/48	- Compact design	12/101 Plastic enclosures
12/50	3SE5, open-type design	12/102 Metal enclosures
12/51	Accessories and spare parts	
	SIRIUS 3SE5, 3SE2 mechanical safety switches	
	<u>With separate actuator</u>	
12/54	General data	
12/59	3SE5, plastic enclosures	
12/61	3SE5, metal enclosures	
12/63	Accessories	
12/64	3SE2, plastic enclosures	
	<u>With solenoid interlocking</u>	
12/65	General data	
12/69	3SE5, plastic enclosures	
12/70	3SE5, metal enclosures	
12/71	Accessories	
	<u>Hinge switches</u>	
12/72	General data	
12/74	3SE5, plastic enclosures	
12/75	3SE5, metal enclosures	
12/76	3SE2, plastic enclosures	
	SIRIUS 3SE5 mechanical position switches for explosion protection	
12/78	General data	
12/79	3SE5, metal enclosures	
	SIRIUS 3SE5 mechanical safety switches for explosion protection	
	<u>With separate actuator</u>	
12/84	3SE5, metal enclosures	
	<u>Hinge switches</u>	
12/85	3SE5, metal enclosures	
	SIRIUS 3SF1 mechanical safety switches for AS-Interface	
	<u>Magnet</u>	
12/103	3SE6 6, 3SE6 7 magnetically operated switches	
	<u>RFID</u>	
12/105	3SE63 RFID safety switches new	
	More information can be found on the Internet: see opening information, page 13	

Position and Safety Switches

Introduction

Overview



**3SE5 23.,
3SE5 21.
3SF1 2.4**

**3SE5 24.,
3SF1 244**

**3SE5 13.,
3SE5 11.,
3SF1 114**

**3SE5 12.,
3SF1 124**

3SE5 16.

**3SE5 232,
3SE5 212,
3SF1 2.4**

**3SE5 132,
3SE5 112,
3SF1 1.4**

	Position switches, standard					Safety hinge switches	
Enclosure							
Plastic	✓	✓	✓	--	--	✓	✓
Metal	✓	--	✓	✓	✓	✓	✓
Dimensions (W x H x D) in mm	31 x 68 x 33	50 x 53 x 33	40 x 78 x 38	56 x 78 x 38	56 x 100 x 38	31 x 68 x 33	40 x 78 x 38
Degree of protection	IP65, IP66/IP67	IP66/IP67	IP66/IP67	IP66/IP67	IP66/IP67	IP65, IP66/IP67	IP66/IP67
Standards							
IEC 60947-5-1	Mounting and operating points acc. to EN 50047	Operating points acc. to EN 50047	Mounting and operating points acc. to EN 50041	Operating points acc. to EN 50041	Operating points acc. to EN 50047	Mounting and operating points acc. to EN 50047	Mounting and operating points acc. to EN 50041
Approvals	CE, UL, CSA, CCC		CE, UL, CSA, CCC			CE, UL, CSA, CCC	
Contact blocks							
2 slow-action contacts	1 NO + 1 NC, 2 NC		1 NO + 1 NC, 2 NC		--	1 NO + 1 NC	
2 snap-action contacts	1 NO + 1 NC		1 NO + 1 NC		--	1 NO + 1 NC	
• Short stroke	1 NO + 1 NC		✓		--	✓	
• With 2 x 2 mm contact gap	1 NO + 1 NC		✓		--	✓	
3 slow-action contacts	1 NO + 2 NC, 2 NO + 1 NC		1 NO + 2 NC, 2 NO + 1 NC		--	1 NO + 2 NC	
• With make-before-break	1 NO + 2 NC		1 NO + 2 NC		--	1 NO + 2 NC	
3 snap-action contacts	1 NO + 2 NC		1 NO + 2 NC		--	1 NO + 2 NC	
2 x (2 or 3 contacts)	--		--		✓	--	
Special features							
LED status display	✓		✓		--	✓	
Increased corrosion protection	✓		✓		✓	✓	
Explosion protection (ATEX)	--		✓		✓	✓	
ASIsafe integrated	✓		✓		--	✓	
Electrical specifications							
Insulation voltage U_i	400 V		400 V			400 V	
Conventional thermal current I_{the}	6 A/10 A (3-/2-pole)		6 A/10 A (3-/2-pole)			6 A/10 A (3-/2-pole)	
Connections							
Cable entry	1 x M20 x 1.5	2 x M20 x 1.5	1 x M20 x 1.5	3 x M20 x 1.5	1 x M20 x 1.5	1 x M20 x 1.5	1 x M20 x 1.5
M12 connector socket, 4-, 5- or 8-pole	✓	✓	✓	✓	✓	✓	✓
Connector socket, 6-pole + PE	--	--	✓	✓	--	--	--
Actuators							
Rounded plungers and roller plungers	✓		✓			--	
Roller and angular roller levers	✓		✓			--	
Spring rod	✓		✓			--	
Twist levers and rod actuators	✓		✓			--	
Fork lever	--		✓			--	
Hinge switches	--		--			✓	
Page							
Complete units	12/13, 12/30	12/22	12/18, 12/34	12/38	12/42	12/74	12/75
Modular system	12/16, 12/32	12/24	12/20, 12/36	12/40	12/43	--	--
Ambient temperature -40 °C	12/26, 12/45	12/26	12/29, 12/46	12/46	12/46	--	--
ASIsafe	12/88, 12/90	12/88	12/92	12/92	--	12/101	12/102
ATEX	12/79	--	12/81	12/81	12/82	12/85	12/85

✓ Available

-- Not available



	Compact design	Open-type	Safety switches with separate actuator		Safety switches with solenoid interlocking	RFID safety switch
Enclosure						
Plastic	--	✓	✓	✓	✓	✓
Metal	✓	--	✓	✓	✓	--
Dimensions (W x H x D) in mm	30 x .. x .., 40 x .. x ..	30 x 48.5 x 20	31 x 68 x 33, 50 x 53 x 33	40 x 78 x 38, 56 x 78 x 38	54 x 185 x 44	25 x 91 x 22
Degree of protection	IP66/IP67	IP10 or IP20	IP65, IP66/IP67	IP66/IP67	IP66/IP67	IP69K
Standards						
IEC 60947-5-1	--	Mounting and operating points acc. to EN 50047	Mounting acc. to EN 50047	Mounting acc. to EN 50041	EN 1088	Category 4 acc. to ISO 13849-1, PL e acc. to ISO 13849-1, SIL 3 acc. to IEC 61508
Approvals	CE, UL, CSA	--	CE, TÜV, UL, CSA, CCC		CE, TÜV, UL, CSA, CCC	CE, TÜV
Contact blocks						
2 slow-action contacts	--	1 NO + 1 NC	1 NO + 1 NC	--	--	--
2 snap-action contacts	1 NO + 1 NC	1 NO + 1 NC	--	--	--	--
• Short stroke	--	✓	--	--	--	--
• With 2 x 2 mm contact gap	--	✓	--	--	--	--
3 slow-action contacts	--	1 NO + 2 NC	1 NO + 2 NC	--	--	--
• With make-before-break	--	1 NO + 2 NC	--	--	--	--
3 snap-action contacts	--	1 NO + 2 NC	--	--	--	--
6 slow-action contacts	--	--	--	--	2 x (1 NO + 2 NC)	--
Special features						
LED status display	--	--	✓	--	✓	✓
Increased corrosion protection	--	--	✓	--	✓	✓
Explosion protection (ATEX)	--	--	✓	--	--	--
ASIsafe integrated	--	--	✓	--	✓	--
Electrical specifications						
Insulation voltage U_i	400 V	400 V	400 V	400 V	400 V	--
Conventional thermal current I_{the}	10 A	6 A	6 A	6 A	6 A	--
Connections						
Cable entry	--	--	1 x M20 x 1.5, 2 x M20 x 1.5	1 x M20 x 1.5, 3 x M20 x 1.5	3 x M20 x 1.5	--
M12 connector socket, 4-, 5- or 8-pole	✓	--	✓	✓	✓	✓
Molded cables	✓	--	--	--	--	--
AS-Interface	--	--	✓	✓	✓	--
Actuators						
Plungers, twist levers	✓	✓	--	--	--	--
Separate actuators	--	--	✓	--	✓	--
Page						
Complete units	12/48	12/50	12/59, 12/61	12/60, 12/62	12/69, 12/70	--
Modular system	--	--	--	--	--	12/105
ASIsafe	--	--	12/95	12/96	12/99, 12/100	--
ATEX	--	--	12/84	12/84	--	--

✓ Available
-- Not available

Note:
Safety characteristics see Chapter 16,
"Appendix" → "Standards and Approvals" → "Overview".

SIRIUS 3SE5 Mechanical Position Switches

General data

Overview

The innovative SIRIUS 3SE5 position switches are modern in design, compact, modular and simple to connect. They save time and increase flexibility during installation of a whole range of switch versions. In principle it is possible to combine any enclosure with any operating mechanism, paying due consideration to the EN 50041 and EN 50047 standards where necessary.

Complete units

Popular versions of the position switches in standard enclosures are available as complete units.



3SE5 position switches with plastic and metal enclosures

Modular system

The 3SE5 series features a new modular system comprising different sizes of the basic switch and an actuator which must be ordered separately. Thanks to the modular design of the switch the user can select the right solution for his application from numerous versions and install it himself in a very short time.

An easy plug-in method enables fast replacement of the actuator heads.



Examples of selection options in the modular system

Design

All enclosure versions have an integrated chlorinated rubber diaphragm (high functional safety in cold and aggressive environments).

Enclosure sizes

The 3SE5 switches are available in five different enclosure sizes with 2 or 3 contacts and with the XL enclosure:

- Open-type position switch IP20 or IP10
- Plastic enclosures according to EN 50047, 31 mm wide, IP65, 1 cable entry
- Metal enclosures according to EN 50047, 31 mm wide, IP66/IP67, 1 cable entry
- Plastic and metal enclosures according to EN 50041, 40 mm wide, IP66/IP67, 1 cable entry
- Plastic enclosures, 50 mm wide, IP66/IP67, 2 cable entries
- Metal enclosures, 56 mm wide, IP66/IP67, 3 cable entries
- XL metal enclosures with 4 to 6 contacts, 56 mm wide, IP66/IP67, 3 cable entries

Enclosure versions

Various basic switches can be selected for the 3SE5 series:

- With contact blocks with two or three contacts (screw terminals) designed as slow-action or snap-action contacts; the slow-action contacts also with make-before-break
- Optional LED status display
- With mounted four- or five-pole M12 connector socket (available for the wide enclosures as an accessory for self-assembly)
- With 6-pole connector socket + PE on the metal enclosures
- Versions with increased corrosion protection
- Versions for operating temperature up to -40 °C
- Metal enclosures for explosion protection (ATEX) ([see page 12/78](#))
- AS-Interface version with integrated ASIsafe electronics for all enclosure designs ([see page 12/86](#))

Actuator versions

All operating mechanisms can be rotated around the axis in increments of 22.5° . The following actuator versions are available:

- Standard, rounded and roller plungers
- Roller and angular roller levers
- Spring rod
- Twist levers and rod actuators with twist actuator
- Fork levers with twist actuator

The actuator rollers are available with various materials and diameters.

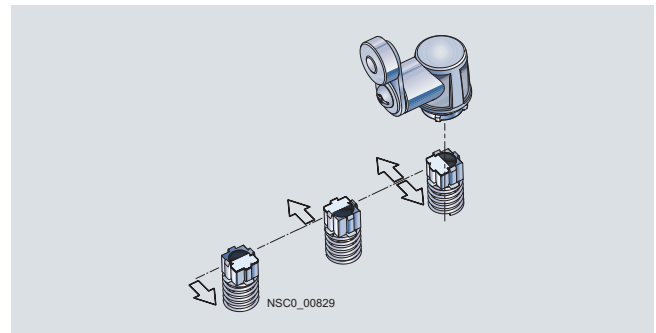

Twist actuators for twist levers and rod actuators, with setting of switching to right, left or right/left (standard for all twist actuators except fork levers)

Optional LED indicators

LED indicators
available for all enclosure sizes.



The enclosure versions can be supplied with an LED signaling indicator (1 × green + 1 × yellow). This is the first time that optical signaling equipment is also available for small standard enclosures according to EN 50047. The LED signaling indicators are available in all common voltages (24 V DC and 230 V AC).

Additional contacts

Exchangeable two and three-pole contact blocks
for all enclosure sizes



The three-pole contact block with snap-action or slow-action contacts is regularly available for all enclosure forms. The same installation space is required as for a two-pole block. The version with 1 NO + 2 NC offers for example more safety through redundant shutdowns (2 NC contacts) with simultaneous signaling (1 NO contact). The three-pole blocks are also available with make-before-break and with 2 NO + 1 NC.

Contact reliability

The new contact blocks ensure an extremely high contact stability. This applies even when the devices are switching low voltages and currents, e.g. 1 mA at 5 V DC.

Positive opening ☞

The NC contacts of the switch are forced open mechanically, positively-driven and reliably by the plunger. This is referred to as "positive opening".

Mounting

Easy plug-in method
for fast replacement of the actuator heads



Open the cover (1)
Actuate the locking lever (2)
Replace the head (turnable by 16 x 22.5°) (3)
Lock and close the cover

Quick-connect technology

For plastic enclosure with a width of 31 mm

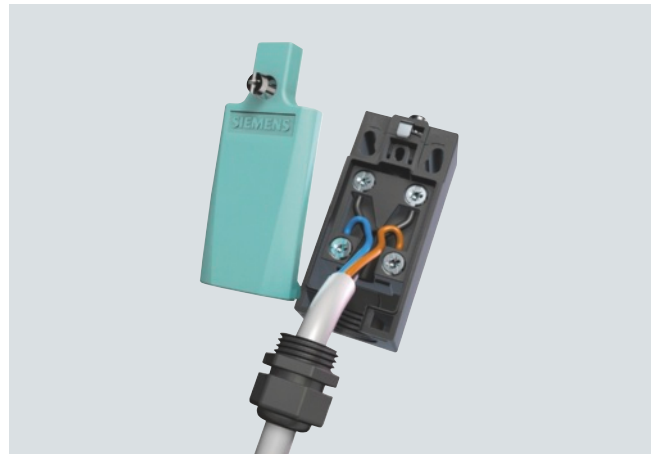

These position switches can be wired quickly and easily as an added customer benefit. The connecting cable is first connected to the terminals of the contact block and then guided through a slit into the cable gland opening. The time saved through this new connection method is approx. 20 to 25 %.

A cable gland with seal must be used with the quick-connect method.

SIRIUS 3SE5 Mechanical Position Switches

General data

Benefits

The 3SE5 position switches differ from the previous series through the following new characteristics:

- The modular design of the product range allows a number of versions with a smaller number of bearing types for enclosures and operating mechanisms.
- All actuators can be turned around the axis in increments of 22.5° (see picture on page 12/5).
- Rounded and roller plungers according to EN 50041 with 3 mm overtravel (total travel 9 mm) for greater tolerance when switching
- All enclosure sizes – now also including the small enclosure 31 mm wide – are optionally available with an LED signaling indicator (see picture on page 12/5).
- All enclosure versions have an integrated chlorinated rubber diaphragm (high functional safety in cold and aggressive environments).
- All contact blocks are replaceable (see page 12/52).
- The three-pole contact blocks are available for all enclosure sizes (see picture on page 12/5).
- Elements with 1 NO + 2 NC slow-action contacts with make-before-break and 2 NO + 1 NC
- The short-stroke contact block 1 NO + 1 NC improves the precision of the switching operation through a reduced actuation path.
- The contact block with 1 NO + 1 NC snap-action contacts with 2 x 2 mm contact opening is suitable for simultaneous disconnection and signaling, particularly in the elevator industry
- **NEW:** XL enclosures for accommodating two 2- or 3-pole contact blocks
- The plastic enclosure with a width of 31 mm has simple and fast wiring equipment which makes it possible to save from approx. 20 to 25 % of the time when connecting (see picture on page 12/5).
- The ASIsafe electric component is integrated for the versions with the AS-Interface connection (see page 12/86); an additional adapter is not required.

Application

With the standard position switches, mechanical positions of moved machine parts are converted into electrical signals. Through their modular and uniform design and large number of versions, the devices can meet practically all requirements in industry.

Devices are available with enclosure versions to suit the particular ambient conditions. Different control tasks can be performed with the best contact blocks suited for the particular purpose. And many different actuator versions are available to match the mechanical configuration of the moved machined parts. Dimensions, fixing points and characteristics are largely in accordance with the EN 50041 or EN 50047 standards.

The devices are suitable for use in any climate.

Standards

IEC 60947-5-1 or EN 60947-5-1.



The protective measure of "total insulation" by the molded-plastic enclosure is guaranteed by the use of molded-plastic screw-glands.

Safety position switches

For controls according to IEC 60204-1 or EN 60204-1 the devices can be used as a safety position switch. To secure position switches against changes in their position, keyed techniques must be employed on installation.

Safety circuits

IEC 60947-5-1 and EN 60947-5-1 require positive opening of the NC contacts, i.e. for the purposes of personal safety, the assured opening of NC contacts is expressly stipulated for the electrical equipment of machines in all safety circuits and marked according to the IEC standard 60947-5-1 with the symbol .

Category 2 according to ISO 13849-1 (EN 954-1) can be attained with 3SE5 position switches with , and category 3 or 4 when using an additional position switch, if the corresponding failsafe evaluation units are selected and correctly installed, e.g. the 3TK28 safety relays or matching devices from the ASIsafe, SIMATIC or SINUMERIK product ranges. The operating mechanisms (actuators) must also be connected to the enclosure by keyed techniques. The corresponding operating mechanisms are marked in the catalog with .

Contacts for each application

- **Snap-action contacts:** NC and NO contacts switch simultaneously – regardless of the actuating speed ($v_{\min} = 0.01$ m/s) and contact erosion.
- **Slow-action contacts:** Difference in travel between "NC contact opens" and "NO contact closes"; the switching speed is the same as or proportional to the actuating speed ($v_{\min} = 0.4$ m/s).
- **Slow-action contacts with make-before-break:** e.g. suitable for adding a second function to a sequence control.

Operating mechanisms for each application

Standard, rounded and roller plungers

- Operation in direction of the plunger axis or in case of roller plunger with bar at right angles to the plunger axis
- The roller plunger is recommended for lateral actuation and relatively long overtravel.

Roller and angular roller levers

- For actuators made of finely ground steel in the form of cams, straight-edges (approach angle 30°) or cam disks

Spring rod

- Can be used for undefined actuations and changing starting conditions
- Starting from any direction is possible

Twist levers and rod actuators

- For a high starting speed ($v = 1.5$ m/s)
- Variety of starting options
- Insensitive to oil, grinding dust and coarse-grained material
- Adjustment of the lever in increments of 10°.
- Can be adjusted with left or right switching

Fork lever

- Switchable in two directions
- Latching actuator
- For reciprocating movements

Technical specifications

Type		3SE5 1..., 3SE5 2..	3SE5 41.	3SE5 42.
General data				
Standards		IEC 60947-5-1, EN 60947-5-1		
Rated insulation voltage U_i	V	400	400	
Pollution degree acc. to IEC 60664-1		Class 3	Class 3	
Rated impulse withstand voltage U_{imp}	kV	6	4	
Rated operational voltage U_e	V	400 V AC, over 300 V AC only for equal potential ¹⁾		300 AC
Conventional thermal current I_{th}	A	10	6	10
Rated operational current I_e		2-pole	3-pole	2-pole
• With alternating current 50/60 Hz		$I_e/AC-15$	$I_e/AC-15$	$I_e/AC-15$
- At 24 V	A	6	6	6
- At 120 V	A	6	3	6
- At 240 V	A	3	1.5	3
• For direct current		$I_e/DC-13$	$I_e/DC-13$	$I_e/DC-13$
- At 24 V	A	3	3	3
- At 125 V	A	0.55	0.55	0.55
- At 250 V	A	0.27	0.27	0.27
Short-circuit protection²⁾				
• With DIAZED fuse links, gG operational class	A	6		
• With miniature circuit breaker, Char. C	A	1	2	1
Mechanical endurance				
• Basic switches		15 × 10 ⁶ operating cycles	30 × 10 ⁶ operating cycles	30 × 10 ⁶ operating cycles
• With spring rod, 3SE5 ...-R..		10 × 10 ⁶ operating cycles	--	--
• With fork lever 3SE5 1...-T..		1 × 10 ⁶ operating cycles	--	--
Electrical endurance				
• With 3RH.1, 3RT contactors in size S00, S0		10 × 10 ⁶ operating cycles	10 × 10 ⁶ operating cycles	5 × 10 ⁶ operating cycles
• For utilization category AC-15 when switching off $I_e/AC-15$ at 240 V		0.1 × 10 ⁶ operating cycles	--	--
• With utilization category DC-12/DC-13		For direct current depending on the loading of the switch		
Switching frequency With 3RH.1, 3RT contactors in size S00, S0		6000 operating cycles/h	1800 operating cycles/h	
Switching accuracy For repeated switching, measured at the plunger of the contact block	mm	0.05		
• With twist actuators		1°		
Rated data acc. to \mathcal{C}, \mathcal{C} and \mathcal{A}.				
• Rated voltage	V	300		
• Uninterrupted current	A	6		
• Switching capacity		Heavy duty, A 300 / B 300 / Q 300	A 300 / Q 300	

¹⁾ For slow-action contacts 1 NO + 2 NC with make-before-break and 2 NO + 1 NC the following applies: over 250 V AC only equal potential

²⁾ Without any welds according to IEC 60947-5-1.

Type		3SE5 23.	3SE5 13	3SE5 24.	3SE5 21.	3SE5 11.	3SE5 12., 3SE5 16.	3SE5 4..	3SE5 25.	
Enclosure										
Enclosure		Ultramid A3X2G7			Zinc diecasting GD Zn Al4 Cu1				--	
• Material										
• Width	mm	31	40	50	31	40	56	30 / 40	30	
Degree of protection acc. to IEC 60529		IP65	IP66/IP67 ¹⁾					IP67	IP20, IP10	
Ambient temperature										
• During operation	°C	-25 ... +85							-25 ... +85	-25 ... +85
• In operation, switch with LEDs	°C	-25 ... +70							--	--
• Storage, transport	°C	-40 ... +90							-40 ... +90	-40 ... +90
Mounting position		Any								
Connection										
Cable entry		1 × (M20 × 1.5)		2 × (M20 × 1.5)	1 × (M20 × 1.5)		3 × (M20 × 1.5)	--	--	
Conductor cross-sections²⁾										
• Solid	mm ²	2 × (0.5 ... 0.75), 1 × (0.5 ... 1.5)								
• Finely stranded with end sleeve	mm ²	2 × (0.5 ... 1.5)								
Tightening torque , contact block	Nm	0.8 ... 1.0								
Protective conductor connection inside enclosure		--			M3.5			--	--	

¹⁾ For twist actuators with spring rod and rod actuators: IP65/IP67.

²⁾ For the maximum number of connectable conductors for the respective contact block see operating instructions.

SIRIUS 3SE5 Mechanical Position Switches

General data

Dimensions of the basic switches

Enclosure width 31 mm, EN 50047, with M20 x 1.5 connecting thread 3SE5 232, 3SE5 212

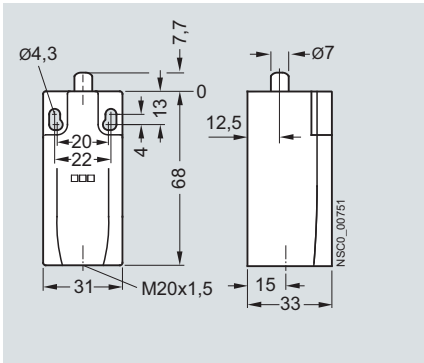

Enclosure width 31 mm, EN 50047, rear with fixing holes 3SE5 232, 3SE5 212

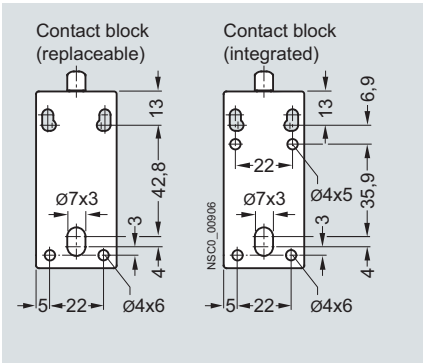

Enclosure width 31 mm, EN 50047, with M12 connector socket 3SE5 234, 3SE5 212

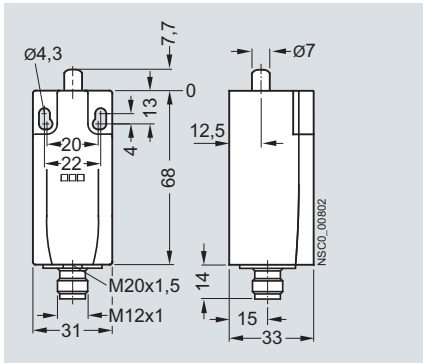

Enclosure width 50 mm, with M20 x 1.5 connecting thread 3SE5 242

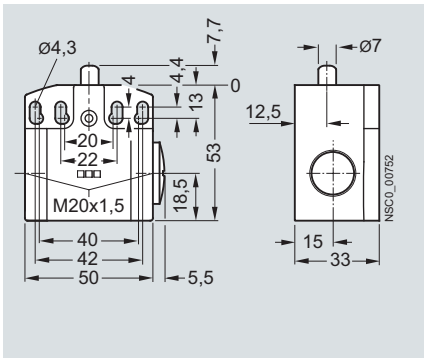

Enclosure width 50 mm, rear with fixing holes 3SE5 242

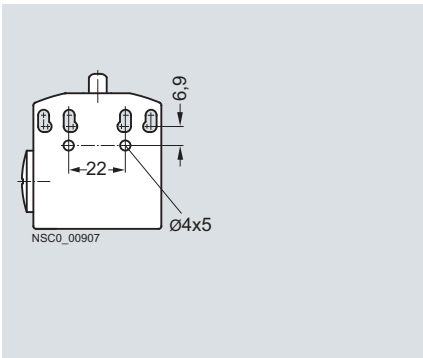

Enclosure width 40 mm, EN 50041, with M20 x 1.5 connecting thread 3SE5 112, 3SE5 132

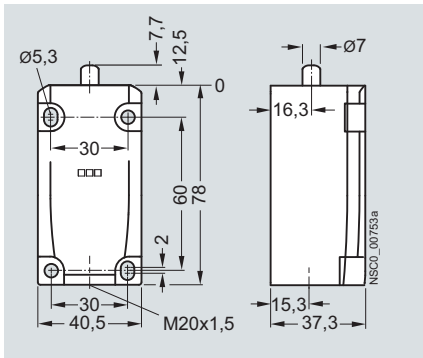

Enclosure width 40 mm, EN 50041, with 6-pole connector socket 3SE5 115

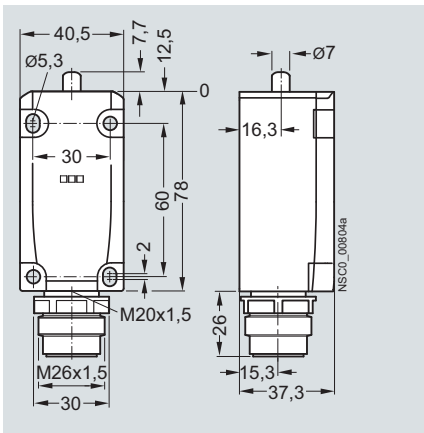

Enclosure width 56 mm, with M20 x 1.5 connecting thread 3SE5 122

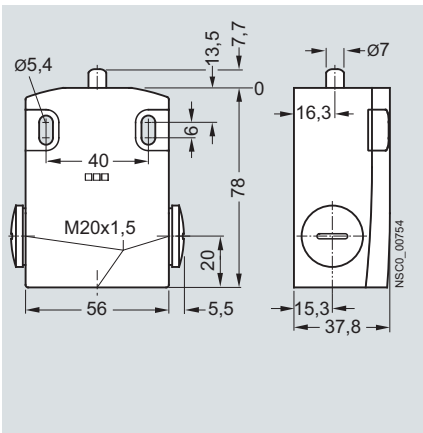

XL enclosure, width 56 mm, with M20 x 1.5 connecting thread 3SE5 162

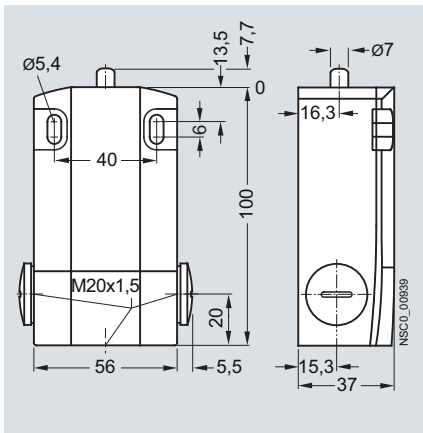

Operating mechanisms for basic switches, see pages 12/9 and 12/10.

Operating mechanisms for enclosure width 31 mm and 50 mm

Roller plunger, type C acc. to EN 50047

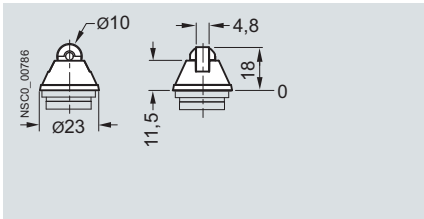

Roller plunger with central fixing

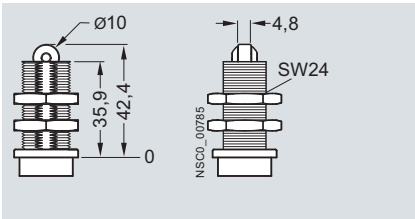

Roller lever, type E acc. to EN 50047

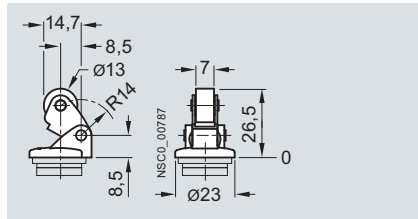

Angular roller lever

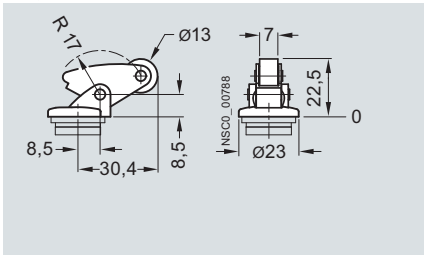

Twist lever, type A acc. to EN 50047

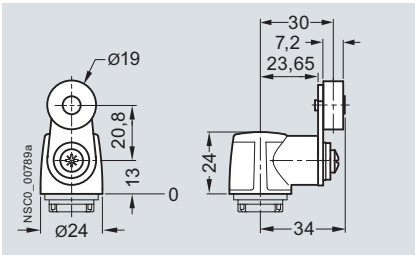

Twist lever, roller 30 mm

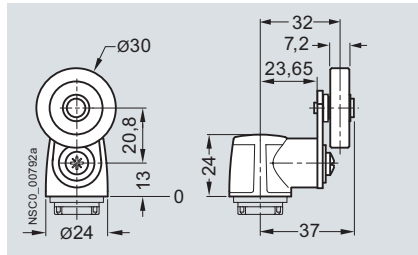

Operating mechanism for enclosure width 40 mm and 56 mm

Plain plunger

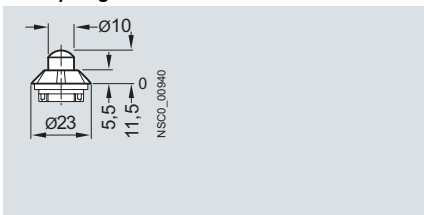

Rounded plunger, type B acc. to EN 50041

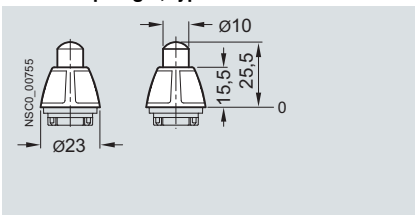

Roller plunger, type C acc. to EN 50041

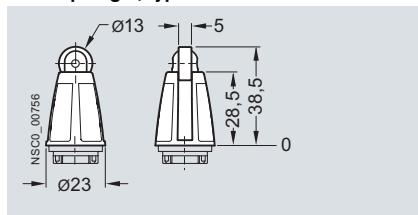

Roller lever

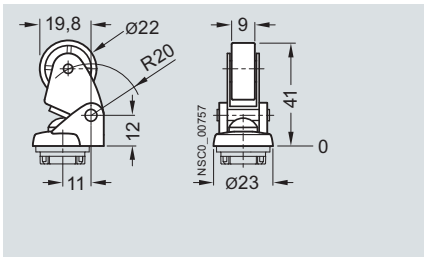

Angular roller lever

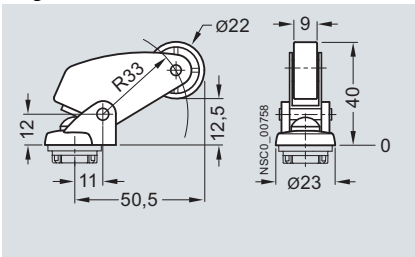

Twist lever, type A acc. to EN 50041

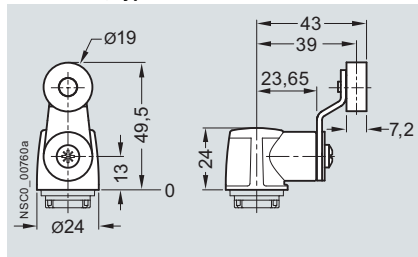

Twist lever, 2 rollers 19 mm

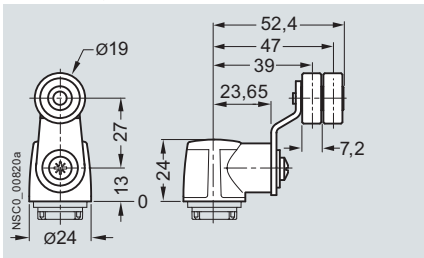

Fork lever, roller 19 mm

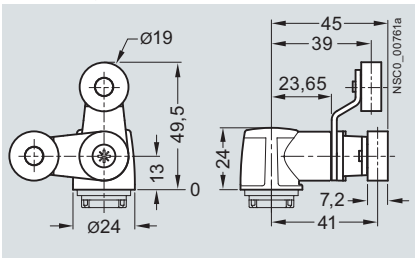

Twist lever, roller 30 mm

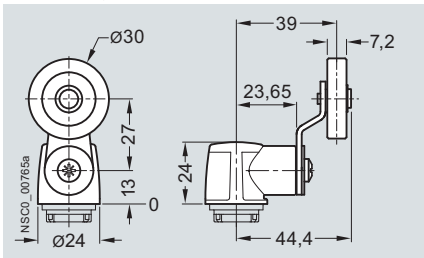

Twist lever, roller 50 mm

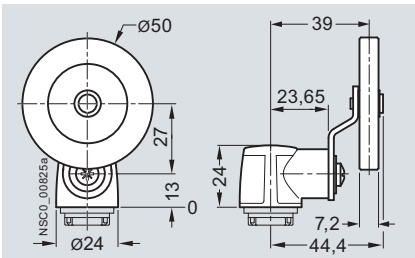

Twist lever, rubber roller 50 mm

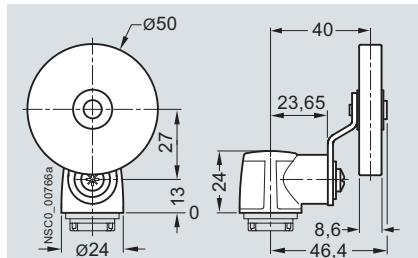

SIRIUS 3SE5 Mechanical Position Switches

General data

Operating mechanisms for all enclosure widths

Twist lever, adjustable length, roller 19 mm

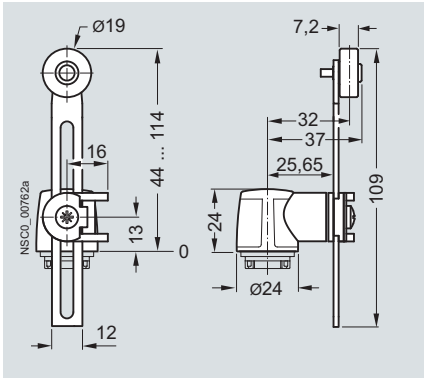

Twist lever, adjustable length, with grid hole, roller 19 mm

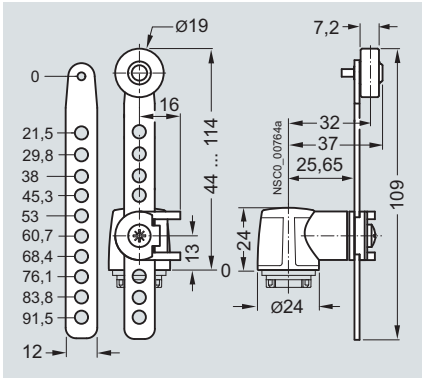

Twist lever, adjustable length, roller 30 mm

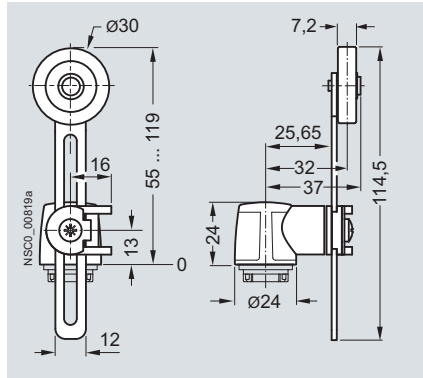

Twist lever, adjustable length, roller 50 mm

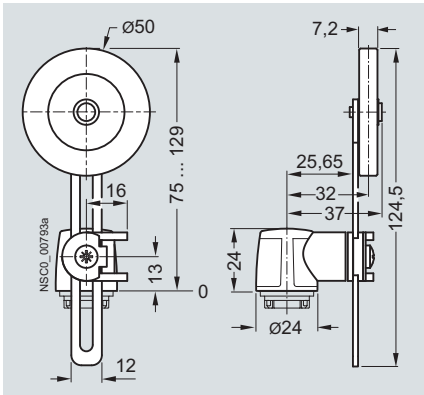

Twist lever, adjustable length, rubber roller 50 mm

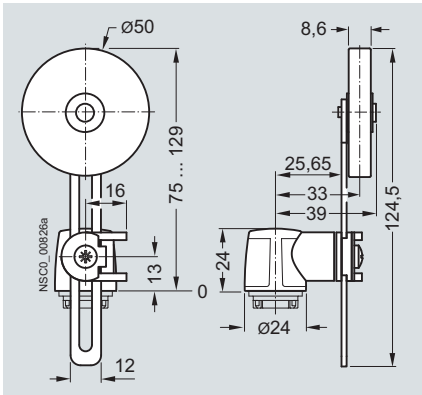

Twist lever, adjustable length, with grid hole, rubber roller 50 mm

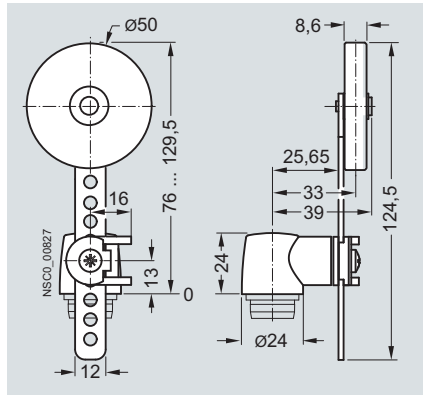

Rod actuator

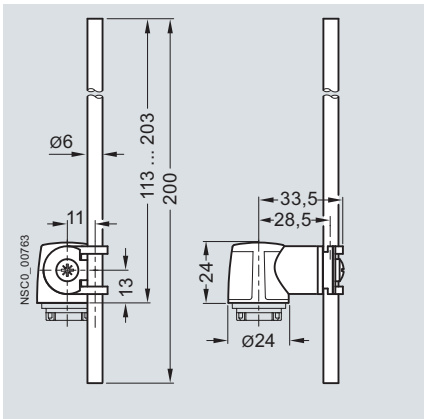

Spring rod, length 142.5 mm

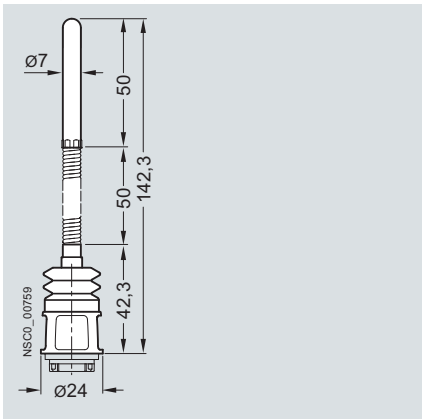

Spring rod, length 242.5 mm

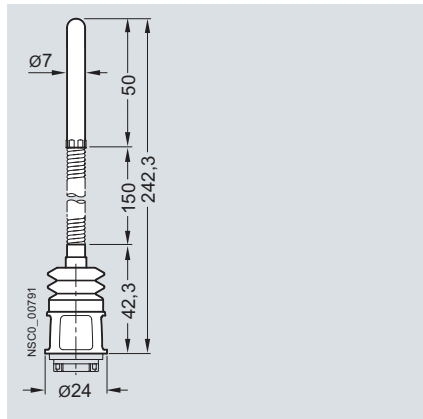

Spring rod, length 76 mm

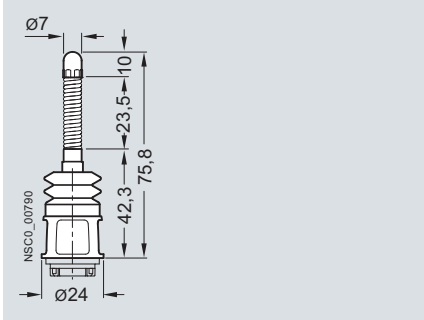

Circuit diagrams

Enclosure widths 31, 40, 50 and 56 mm

Slow-action contacts
1 NO + 1 NC
3SE5 ...-B..., -R...

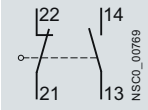

Slow-action contacts
2 NO + 1 NC
3SE5 ...-P...

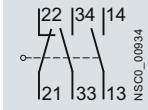

Snap-action contacts
1 NO + 1 NC
3SE5 ...-C..., -F..., -G..., -H..., -N...

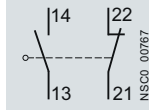

Slow-action contacts
1 NO + 2 NC
3SE5 ...-K..., -Q...

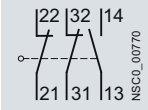

Slow-action contacts
1 NO + 2 NC with make-before-break, 3SE5 ...-M...

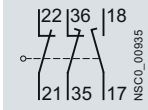

Snap-action contacts
1 NO + 2 NC
3SE5 ...-L...

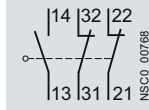

XL enclosures, width 56 mm

Slow-action contacts
2 x (1 NO + 1 NC)
3SE5 162-0B...

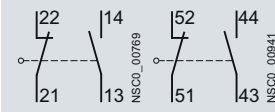

Slow-action contacts
2 x (1 NO + 2 NC) with make-before-break, 3SE5 162-0D...

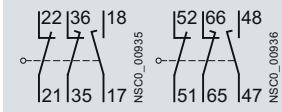

For slow-action contacts
1 NO + 2 NC with make-before-break, 1 NO + 1 NC, 3SE5 162-0E...

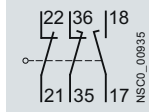

Snap-action contacts
2 x (1 NO + 1 NC)
3SE5 162-0C...

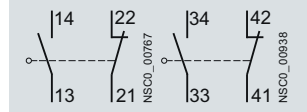

3SE5 connector assignment

M12 connector socket, 4-pole
3SY3 127

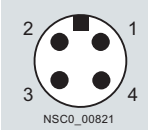

M12 connector socket, 5-pole
3SY3 128

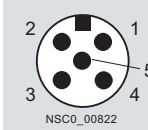

M12 connector socket, 8-pole
3SY3 134

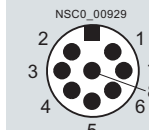

Connector sockets, 6-pole + PE
3SY3 131

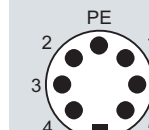

Order No.	Connector sockets Type	Contacts Version	LEDs Version	Connections										
				Pin 1	Pin 2	Pin 3	Pin 4	Pin 5	Pin 6	Pin 7	Pin 8	PE		
M12 connector sockets (4-, 5- or 8-pole)														
3SE5..4-0....-1AC4	3SY3 127	1 NO + 1 NC	--	21	22	13	14	--	--	--	--	--	--	--
3SE5..4-0....-1AC5	3SY3 128	1 NO + 1 NC	--	21	22	13	14	PE	--	--	--	--	--	--
3SE5..4-0....-1AE0	3SY3 127	2 NC	--	21	22	31	32	--	--	--	--	--	--	--
3SE5..4-0....-1AE1	3SY3 128	2 NC	--	21	22	31	32	PE	--	--	--	--	--	--
3SE5..4-1C...-1AF3	3SY3 128	1 NO + 1 NC snap action	2 LEDs	21	22	13 / LED gn	14 / LED ye	Ground LED	--	--	--	--	--	--
3SE5..4-1B...-1AF3	3SY3 128	1 NO + 1 NC slow-action	2 LEDs	21	22	14 / LED gn	13 / LED ye	Ground LED	--	--	--	--	--	--
3SE5..4-1L...-1AD4	3SY3 134	1 NO + 2 NC snap action	2 LEDs	21	22	13 / LED gn	14 / LED ye	31	32	Ground LED	PE	--	--	--
3SE5..4-1K...-1AD4	3SY3 134	1 NO + 2 NC slow-action	2 LEDs	21	22	14 / LED gn	13 / LED ye	31	32	Ground LED	PE	--	--	--
Connector sockets, 6-pole + PE														
3SE5..5-0....-1AD0	3SY3 131	1 NO + 1 NC	--	21	22	13	14	--	--	--	--	--	--	✓
3SE5..5-0....-1AD1	3SY3 131	1 NO + 2 NC	--	21	22	13	14	31	32	--	--	--	--	✓
3SE5..5-.C...-1AF2	3SY3 131	1 NO + 1 NC snap action	2 LEDs	21	22	13 / LED gn	14 / LED ye	--	Ground LED	--	--	--	--	✓
3SE5..5-.B...-1AF2	3SY3 131	1 NO + 1 NC slow-action	2 LEDs	21	22	14 / LED gn	13 / LED ye	--	Ground LED	--	--	--	--	✓
3SE5..5-.L...-1AD2	3SY3 131	2 NC snap-action	2 LEDs	21	22	31	32	13 / LED gn	Ground LED	--	--	--	--	✓
3SE5..5-.K...-1AD2	3SY3 131	2 NC slow-action	2 LEDs	21	22	31	32	14 / LED gn	Ground LED	--	--	--	--	✓

gn Green
ye Yellow

✓ Connected
-- Not available

SIRIUS 3SE5 Mechanical Position Switches

General data

Options

On the following pages you will find selection tables for complete units as well as components of the modular system.

- Complete units
- Modular system

The differences between the units are indicated in the selection and ordering data by the symbols shown on orange backgrounds.

Using the modular system you can assemble switch versions which are not available as complete units. Each complete unit can also be supplied as a module.

A basic switch for the modular system comprises an enclosure with a contact block and a cover. Among the basic switches the following versions, for example, can be selected:

- Basic enclosure with teflon plunger
- Version with increased corrosion protection

- Version with 2 LEDs
- Version with M12 connector socket or 6-pole + PE
- Version with M12 connector socket and with 2 LEDs

For the enclosures with a width of 31 and 50 mm the basic switches are designed as complete units with rounded plunger (according to standard).

Online configurator

The online configurator for 3SE5/3SF1 helps you not only to select and order the right position switch but also to create complete product documentation.

- Product data sheets
- Dimensional drawings
- Operating travel diagrams
- CAD data in 2D and 3D model images
- Ordering data
- Product photos

www.siemens.com/sirius/configurators

Complete units

Ordering example

Required:

- Position switch according to EN 50047 in a plastic enclosure
- Contact block with slow-action contacts 1 NO + 1 NC
- Angular roller lever, metal lever and plastic roller

To be ordered:

Version	Complete units
	<input type="checkbox"/>
Order No.	
Complete units • Enclosure width 31 mm	
 <p>Angular roller levers With metal lever and plastic roller 13 mm Slow-action contacts 1 NO + 1 NC</p>	3SE5 232-0BF10



Modular system

Ordering example 1

Required:

- Position switch according to EN 50047 in a plastic enclosure
- Contact block with slow-action contacts 1 NO + 1 NC
- Angular roller lever, metal lever and plastic roller

To be ordered separately:



Version	Modular system
	<input checked="" type="checkbox"/>
Order No.	
Basic switches • Enclosure width 31 mm	
 <p>With teflon plunger Slow-action contacts 1 NO + 1 NC</p>	3SE5 232-0BC05
+	
Operating mechanisms	
 <p>Angular roller levers Metal lever, plastic roller</p>	3SE5 000-0AF10

Ordering example 2

Required:

- Position switch according to EN 50047 in a plastic enclosure
- Contact block with slow-action contacts 1 NO + 1 NC
- Twist lever, high-grade steel lever and plastic roller

To be ordered separately:

Version	Modular system
	<input checked="" type="checkbox"/>
Order No.	
Basic switches • Enclosure width 31 mm	
 <p>With teflon plunger Slow-action contacts 1 NO + 1 NC</p>	3SE5 232-0BC05
+	
Twist actuators	
 <p>Twist actuator</p>	3SE5 000-0AK00
 <p>Twist levers High-grade steel lever, plastic roller</p>	3SE5 000-0AA31





Selection and ordering data

Complete units

2 or 3 contacts · Degree of protection IP65 · Cable entry M20 × 1.5¹⁾

Version	Contacts	LEDs	DT	Complete units	<input type="checkbox"/>	PU (UNIT, SET, M)	PS*	PG
				Configurator				
				Order No.		Price per PU		

Complete units²⁾ · Enclosure width 31 mm

	Rounded plungers, type B, acc. to EN 50047								
	With teflon plunger								
	Slow-action contacts	1 NO + 1 NC	--	⊕ ▶	3SE5 232-0BC05		1	1 unit	41K
	Snap-action contacts	1 NO + 1 NC	--	⊕ B	3SE5 232-0CC05		1	1 unit	41K
	Snap-action contacts, integrated ³⁾	1 NO + 1 NC	--	⊕ ▶	3SE5 232-0HC05		1	1 unit	41K
	Snap-action contacts • Short stroke, integrated ³⁾	1 NO + 1 NC	--	⊕ B	3SE5 232-0FC05		1	1 unit	41K
	Snap-action contacts • 2 × 2 mm contact gap	1 NO + 1 NC	--	⊕ B	3SE5 232-0GC05		1	1 unit	41K
	Slow-action contacts	1 NO + 2 NC	--	⊕ ▶	3SE5 232-0KC05		1	1 unit	41K
	Snap-action contacts	1 NO + 2 NC	--	⊕ ▶	3SE5 232-0LC05		1	1 unit	41K
	Slow-action contacts with make-before-break	1 NO + 2 NC	--	⊕ A	3SE5 232-0MC05		1	1 unit	41K
	Slow-action contacts	2 NO + 1 NC	--	⊕ A	3SE5 232-0PC05		1	1 unit	41K
	With increased corrosion protection								
	Slow-action contacts	1 NO + 1 NC	--	⊕ B	3SE5 232-0BC05-1CA0		1	1 unit	41K
	Snap-action contacts	1 NO + 1 NC	--	⊕ B	3SE5 232-0CC05-1CA0		1	1 unit	41K
	Slow-action contacts	1 NO + 2 NC	--	⊕ B	3SE5 232-0KC05-1CA0		1	1 unit	41K
	Snap-action contacts	1 NO + 2 NC	--	⊕ B	3SE5 232-0LC05-1CA0		1	1 unit	41K
	Slow-action contacts with make-before-break	1 NO + 2 NC	--	⊕ B	3SE5 232-0MC05-1CA0		1	1 unit	41K
	Slow-action contacts	2 NO + 1 NC	--	⊕ B	3SE5 232-0PC05-1CA0		1	1 unit	41K
	With M12 connector socket, 4-pole (250 V, 4 A)								
	Slow-action contacts	1 NO + 1 NC	--	⊕ B	3SE5 234-0BC05-1AC4		1	1 unit	41K
	Snap-action contacts, integrated ³⁾	1 NO + 1 NC	--	⊕ A	3SE5 234-0HC05-1AC4		1	1 unit	41K
	Slow-action contacts	2 NC	--	⊕ B	3SE5 234-0KC05-1AE0		1	1 unit	41K
	Snap-action contacts	2 NC	--	⊕ A	3SE5 234-0LC05-1AE0		1	1 unit	41K
	With 2 LEDs, yellow/green								
	Slow-action contacts	1 NO + 2 NC	24 V DC	⊕ B	3SE5 232-1KC05		1	1 unit	41K
	Snap-action contacts	1 NO + 2 NC	24 V DC	⊕ B	3SE5 232-1LC05		1	1 unit	41K
	Slow-action contacts	1 NO + 2 NC	230 V AC	⊕ B	3SE5 232-3KC05		1	1 unit	41K
	Snap-action contacts	1 NO + 2 NC	230 V AC	⊕ B	3SE5 232-3LC05		1	1 unit	41K
	With M12 connector socket, 5-pole (125 V, 4 A) and 2 LEDs								
	Slow-action contacts	1 NO + 1 NC	24 V DC	⊕ B	3SE5 234-1BC05-1AF3		1	1 unit	41K
	Snap-action contacts	1 NO + 1 NC	24 V DC	⊕ B	3SE5 234-1CC05-1AF3		1	1 unit	41K

For online configurator see www.siemens.com/sirius/configurators.

⊕ Positive opening according to IEC 60947-5-1, Appendix K.

¹⁾ A cable gland with seal must be used with the quick-connect method.

²⁾ Popular versions.

³⁾ Subsequent replacement of contact blocks is not possible.

SIRIUS 3SE5 Mechanical Position Switches

3SE5, plastic enclosures Enclosure width 31 mm acc. to EN 50047

2 or 3 contacts · Degree of protection IP65 · Cable entry M20 × 1.5¹⁾

Version	Contacts	LEDs	DT	Complete units	<input type="checkbox"/>	PU (UNIT, SET, M)	PS*	PG
				Configurator				
				Order No.	Price per PU			

Complete units²⁾ · Enclosure width 31 mm



Roller plunger

Roller plungers, type C acc. to EN 50047

With plastic roller 10 mm

Slow-action contacts	1 NO + 1 NC --	⊕ B	3SE5 232-0BD03	1	1 unit	41K
Snap-action contacts • Integrated ³⁾	1 NO + 1 NC --	⊕ ▶	3SE5 232-0HD03	1	1 unit	41K
Snap-action contacts • Short stroke, integrated ³⁾	1 NO + 1 NC --	⊕ B	3SE5 232-0FD03	1	1 unit	41K
Slow-action contacts	1 NO + 2 NC --	⊕ B	3SE5 232-0KD03	1	1 unit	41K
Snap-action contacts	1 NO + 2 NC --	⊕ B	3SE5 232-0LD03	1	1 unit	41K

Actuator head rotated by 90°

Snap-action contacts	1 NO + 2 NC --	⊕ B	3SE5 232-0LD03-1AH0	1	1 unit	41K
----------------------	----------------	-----	---------------------	---	--------	-----

With M12 connector socket, 4-pole (250 V, 4 A)

Snap-action contacts, integrated ³⁾	1 NO + 1 NC --	⊕ B	3SE5 234-0HD03-1AC4	1	1 unit	41K
--	----------------	-----	---------------------	---	--------	-----

Roller plungers with central fixing

Snap-action contacts, integrated ³⁾	1 NO + 1 NC --	⊕ B	3SE5 232-0HD10	1	1 unit	41K
Slow-action contacts	1 NO + 2 NC --	⊕ B	3SE5 232-0KD10	1	1 unit	41K



Roller plunger
with central
fixing

Roller levers, type E acc. to EN 50047

With metal lever and plastic roller 13 mm

Slow-action contacts	1 NO + 1 NC --	⊕ A	3SE5 232-0BE10	1	1 unit	41K
Snap-action contacts, integrated ³⁾	1 NO + 1 NC --	⊕ ▶	3SE5 232-0HE10	1	1 unit	41K
Slow-action contacts	1 NO + 2 NC --	⊕ B	3SE5 232-0KE10	1	1 unit	41K
Snap-action contacts	1 NO + 2 NC --	⊕ B	3SE5 232-0LE10	1	1 unit	41K

With M12 connector socket, 4-pole (250 V, 4 A)

Snap-action contacts, integrated ³⁾	1 NO + 1 NC --	⊕ B	3SE5 234-0HE10-1AC4	1	1 unit	41K
--	----------------	-----	---------------------	---	--------	-----

Angular roller levers

With metal lever and plastic roller 13 mm

Slow-action contacts	1 NO + 1 NC --	⊕ B	3SE5 232-0BF10	1	1 unit	41K
Snap-action contacts, integrated ³⁾	1 NO + 1 NC --	⊕ A	3SE5 232-0HF10	1	1 unit	41K
Slow-action contacts	1 NO + 2 NC --	⊕ B	3SE5 232-0KF10	1	1 unit	41K
Snap-action contacts	1 NO + 2 NC --	⊕ B	3SE5 232-0LF10	1	1 unit	41K



Angular roller
lever

For online configurator see www.siemens.com/sirius/configurators.

⊕ Positive opening according to IEC 60947-5-1, Appendix K.

¹⁾ A cable gland with seal must be used with the quick-connect method.

²⁾ Popular versions.

³⁾ Subsequent replacement of contact blocks is not possible.





SIRIUS 3SE5 Mechanical Position Switches

3SE5, plastic enclosures
Enclosure width 31 mm acc. to EN 50047

2 or 3 contacts · Degree of protection IP65 · Cable entry M20 × 1.5¹⁾

Version	Contacts	LEDs	DT	Complete units	<input type="checkbox"/>	PU (UNIT, SET, M)	PS*	PG
				Configurator				
				Order No.		Price per PU		

Complete units²⁾ · Enclosure width 31 mm

	Spring rods								
	Length 142.5 mm, with plastic plunger 50 mm								
	Snap-action contacts, integrated ³⁾	1 NO + 1 NC --		A	3SE5 232-0HR01		1	1 unit 41K	
	With M12 connector socket, 4-pole (250 V, 4 A)								
	Snap-action contacts, integrated ³⁾	1 NO + 1 NC --		B	3SE5 234-0HR01-1AC4		1	1 unit 41K	
	Twist levers, type A acc. to EN 50047								
	With metal lever 21 mm and plastic roller 19 mm								
		Slow-action contacts	1 NO + 1 NC --		A	3SE5 232-0BK21		1	1 unit 41K
		Snap-action contacts, integrated ³⁾	1 NO + 1 NC --		B	3SE5 232-0HK21		1	1 unit 41K
		Slow-action contacts	1 NO + 2 NC --		B	3SE5 232-0KK21		1	1 unit 41K
		Snap-action contacts	1 NO + 2 NC --		B	3SE5 232-0LK21		1	1 unit 41K
	With M12 connector socket, 4-pole (250 V, 4 A)								
	Snap-action contacts, integrated ³⁾	1 NO + 1 NC --		B	3SE5 234-0HK21-1AC4		1	1 unit 41K	
	With metal lever 35 mm and plastic roller 19 mm								
	Snap-action contacts, integrated ³⁾	1 NO + 1 NC --		B	3SE5 232-0HK15		1	1 unit 41K	
	Twist levers, adjustable length								
	With metal lever with grid hole and plastic roller 19 mm								
		Snap-action contacts, integrated ³⁾	1 NO + 1 NC --		A	3SE5 232-0HK60		1	1 unit 41K
		With metal lever and plastic roller 19 mm							
		Slow-action contacts	1 NO + 1 NC --		B	3SE5 232-0BK50		1	1 unit 41K
		Snap-action contacts, integrated ³⁾	1 NO + 1 NC --		B	3SE5 232-0HK50		1	1 unit 41K
	Snap-action contacts	1 NO + 2 NC --		B	3SE5 232-0LK50		1	1 unit 41K	
	With M12 connector socket, 4-pole (250 V, 4 A)								
	Snap-action contacts, integrated ³⁾	1 NO + 1 NC --		B	3SE5 234-0HK50-1AC4		1	1 unit 41K	
	Rod actuators								
	With aluminum rod, length 200 mm								
		Snap-action contacts, integrated ³⁾	1 NO + 1 NC --		B	3SE5 232-0HK80		1	1 unit 41K
	With plastic rod, length 200 mm								
	Snap-action contacts, integrated ³⁾	1 NO + 1 NC --		B	3SE5 232-0HK82		1	1 unit 41K	
	With M12 connector socket, 4-pole (250 V, 4 A)								
	Snap-action contacts, integrated ³⁾	1 NO + 1 NC --		B	3SE5 234-0HK82-1AC4		1	1 unit 41K	

For online configurator see www.siemens.com/sirius/configurators.

Positive opening according to IEC 60947-5-1, Appendix K.

¹⁾ A cable gland with seal must be used with the quick-connect method.

²⁾ Popular versions.

³⁾ Subsequent replacement of contact blocks is not possible.

Note:







If the device you require is not available as a complete unit, see "Modular System", page 12/16.

SIRIUS 3SE5 Mechanical Position Switches

3SE5, plastic enclosures Enclosure width 31 mm acc. to EN 50047

Modular system

2 or 3 contacts · Degree of protection IP65 · Cable entry M20 × 1.5¹⁾

Version	Contacts	LEDs	DT	Modular system	PU (UNIT, SET, M)	PS*	PG
							
							
				Order No.	Price per PU		
Basic switches · Enclosure width 31 mm (with rounded plunger²⁾)							
 Basic switch	With teflon plunger						
	Slow-action contacts	1 NO + 1 NC --	⊕ ▶	3SE5 232-0BC05	1	1 unit	41K
	Snap-action contacts	1 NO + 1 NC --	⊕ B	3SE5 232-0CC05	1	1 unit	41K
	Snap-action contacts, integrated ³⁾	1 NO + 1 NC --	⊕ ▶	3SE5 232-0HC05	1	1 unit	41K
	Snap-action contacts • Short stroke, integrated ³⁾	1 NO + 1 NC --	⊕ B	3SE5 232-0FC05	1	1 unit	41K
	Snap-action contacts • 2 × 2 mm contact gap	1 NO + 1 NC --	⊕ B	3SE5 232-0GC05	1	1 unit	41K
	Slow-action contacts	1 NO + 2 NC --	⊕ ▶	3SE5 232-0KC05	1	1 unit	41K
	Snap-action contacts	1 NO + 2 NC --	⊕ ▶	3SE5 232-0LC05	1	1 unit	41K
	Slow-action contacts with make-before-break	1 NO + 2 NC --	⊕ A	3SE5 232-0MC05	1	1 unit	41K
	Slow-action contacts	2 NO + 1 NC --	⊕ A	3SE5 232-0PC05	1	1 unit	41K
 With increased corrosion protection	With increased corrosion protection⁴⁾						
	Slow-action contacts	1 NO + 1 NC --	⊕ B	3SE5 232-0BC05-1CA0	1	1 unit	41K
	Snap-action contacts	1 NO + 1 NC --	⊕ B	3SE5 232-0CC05-1CA0	1	1 unit	41K
	Slow-action contacts	1 NO + 2 NC --	⊕ B	3SE5 232-0KC05-1CA0	1	1 unit	41K
	Snap-action contacts	1 NO + 2 NC --	⊕ B	3SE5 232-0LC05-1CA0	1	1 unit	41K
	Slow-action contacts with make-before-break	1 NO + 2 NC --	⊕ B	3SE5 232-0MC05-1CA0	1	1 unit	41K
	Slow-action contacts	2 NO + 1 NC --	⊕ B	3SE5 232-0PC05-1CA0	1	1 unit	41K
 With M12 socket	With M12 connector socket, 4-pole (250 V, 4 A)						
	Slow-action contacts	1 NO + 1 NC --	⊕ B	3SE5 234-0BC05-1AC4	1	1 unit	41K
	Snap-action contacts, integrated ³⁾	1 NO + 1 NC --	⊕ A	3SE5 234-0HC05-1AC4	1	1 unit	41K
	Slow-action contacts	2 NC --	⊕ B	3SE5 234-0KC05-1AE0	1	1 unit	41K
	Snap-action contacts	2 NC --	⊕ A	3SE5 234-0LC05-1AE0	1	1 unit	41K
 With 2 LEDs	With 2 LEDs, yellow/green						
	Slow-action contacts	1 NO + 2 NC 24 V DC	⊕ B	3SE5 232-1KC05	1	1 unit	41K
	Snap-action contacts	1 NO + 2 NC 24 V DC	⊕ B	3SE5 232-1LC05	1	1 unit	41K
	Slow-action contacts	1 NO + 2 NC 230 V AC	⊕ B	3SE5 232-3KC05	1	1 unit	41K
	Snap-action contacts	1 NO + 2 NC 230 V AC	⊕ B	3SE5 232-3LC05	1	1 unit	41K
 With M12 socket and 2 LEDs	With M12 connector socket, 5-pole (125 V, 4 A) and 2 LEDs						
	Slow-action contacts	1 NO + 1 NC 24 V DC	⊕ B	3SE5 234-1BC05-1AF3	1	1 unit	41K
	Snap-action contacts	1 NO + 1 NC 24 V DC	⊕ B	3SE5 234-1CC05-1AF3	1	1 unit	41K

 For online configurator see www.siemens.com/sirius/configurators.

 Positive opening according to IEC 60947-5-1, Appendix K, or positively driven actuator, necessary in safety circuits.

¹⁾ A cable gland with seal must be used with the quick-connect method.

²⁾ For enclosures with widths of 31mm, the basic switch is a complete unit with rounded plungers.

³⁾ Subsequent replacement of contact blocks is not possible.









⁴⁾ Use corresponding high-grade steel lever.

Note:

Selection aid see page 12/12.

SIRIUS 3SE5 Mechanical Position Switches

3SE5, plastic enclosures
Enclosure width 31 mm acc. to EN 50047

Version	Diameter	DT	Modular system	PU (UNIT, SET, M)	PS*	PG	
	mm		Order No.	Price per PU			
Operating mechanisms							
 Roller plunger	Roller plungers, type C acc. to EN 50047						
	Plastic rollers	10	⊕ A	3SE5 000-0AD03	1	1 unit	41K
	High-grade steel rollers	10	⊕ B	3SE5 000-0AD04	1	1 unit	41K
 With central fixing	Roller plungers with central fixing						
	Plastic rollers	10	⊕ B	3SE5 000-0AD10	1	1 unit	41K
	High-grade steel rollers	10	⊕ B	3SE5 000-0AD11	1	1 unit	41K
 Roller lever	Roller levers, type E acc. to EN 50047						
	Metal lever, plastic roller	13	⊕ A	3SE5 000-0AE10	1	1 unit	41K
	Metal lever, high-grade steel roller	13	⊕ B	3SE5 000-0AE11	1	1 unit	41K
	High-grade steel lever, plastic roller	13	⊕ B	3SE5 000-0AE12	1	1 unit	41K
	High-grade steel lever, high-grade steel roller	13	⊕ B	3SE5 000-0AE13	1	1 unit	41K
 Angular roller lever	Angular roller levers						
	Metal lever, plastic roller	13	⊕ A	3SE5 000-0AF10	1	1 unit	41K
	Metal lever, high-grade steel roller	13	⊕ B	3SE5 000-0AF11	1	1 unit	41K
	High-grade steel lever, plastic roller	13	⊕ A	3SE5 000-0AF12	1	1 unit	41K
	High-grade steel lever, high-grade steel roller	13	⊕ B	3SE5 000-0AF13	1	1 unit	41K
 Spring rod	Spring rods (for switches with snap-action contacts only)						
	Plastic plunger and high-grade steel spring:	7					
	• Length 142.5 mm (spring 50 mm, plunger 50 mm)		B	3SE5 000-0AR01	1	1 unit	41K
	• Length 76 mm (spring 23.5 mm, plunger 10 mm)		B	3SE5 000-0AR03	1	1 unit	41K
	• Length 242.5 mm (spring 150 mm, plunger 50 mm)		B	3SE5 000-0AR04	1	1 unit	41K
High-grade steel plunger and spring:	7						
• Length 142.5 mm (spring 50 mm, plunger 50 mm)		B	3SE5 000-0AR02	1	1 unit	41K	
Twist actuators							
 Twist actuator	Twist actuators, plastic (without lever)						
	Switching right and/or left, adjustable		⊕ A	3SE5 000-0AK00	1	1 unit	41K
 Twist lever	Levers for twist actuators						
	Twist levers 21 mm, straight, type A acc. to EN 50047						
	Metal lever, plastic roller	19	⊕ A	3SE5 000-0AA21	1	1 unit	41K
	Metal lever, high-grade steel roller	19	⊕ B	3SE5 000-0AA22	1	1 unit	41K
	Metal lever, roller with ball bearing	19	⊕ B	3SE5 000-0AA23	1	1 unit	41K
	Metal lever, plastic roller	30	⊕ B	3SE5 000-0AA25	1	1 unit	41K
	High-grade steel lever, plastic roller	19	⊕ B	3SE5 000-0AA31	1	1 unit	41K
	High-grade steel lever, high-grade steel roller	19	⊕ B	3SE5 000-0AA32	1	1 unit	41K
	Twist levers 30 mm, straight¹⁾						
	Metal lever, plastic roller	19	⊕ B	3SE5 000-0AA24	1	1 unit	41K
 Twist lever, adjustable length	Twist levers, adjustable length, with grid hole						
	Metal lever, plastic roller	19	⊕ B	3SE5 000-0AA60	1	1 unit	41K
	Metal lever, high-grade steel roller	19	⊕ B	3SE5 000-0AA61	1	1 unit	41K
	Metal lever, plastic roller	50	⊕ B	3SE5 000-0AA67	1	1 unit	41K
	Metal lever, rubber roller	50	⊕ B	3SE5 000-0AA68	1	1 unit	41K
	High-grade steel lever, plastic roller	19	⊕ B	3SE5 000-0AA62	1	1 unit	41K
	High-grade steel lever, high-grade steel roller	19	⊕ B	3SE5 000-0AA63	1	1 unit	41K
Twist levers, adjustable length							
Metal lever, plastic roller	19	A	3SE5 000-0AA50	1	1 unit	41K	
Metal lever, high-grade steel roller	19	B	3SE5 000-0AA51	1	1 unit	41K	
Metal lever, plastic roller	30	B	3SE5 000-0AA55	1	1 unit	41K	
Metal lever, plastic roller	50	B	3SE5 000-0AA57	1	1 unit	41K	
Metal lever, rubber roller	50	B	3SE5 000-0AA58	1	1 unit	41K	
High-grade steel lever, plastic roller	19	B	3SE5 000-0AA52	1	1 unit	41K	
High-grade steel lever, high-grade steel roller	19	B	3SE5 000-0AA53	1	1 unit	41K	
 Rod actuator	Rod actuators						
	Aluminum rod, length 200 mm	6	B	3SE5 000-0AA80	1	1 unit	41K
	Spring rod, length 200 mm	6	B	3SE5 000-0AA81	1	1 unit	41K
	Plastic rod, length 200 mm	6	B	3SE5 000-0AA82	1	1 unit	41K

⊕ Positively driven actuator, necessary in safety circuits.

¹⁾ Can be clinch mounted (turned through 180°, rear of lever).

SIRIUS 3SE5 Mechanical Position Switches

3SE5, plastic enclosures
Enclosure width 40 mm acc. to EN 50041

Selection and ordering data

Complete units

2 or 3 contacts · Degree of protection IP66/67 · Cable entry M20 × 1.5

Version	Contacts	LEDs	DT	Complete units	<input type="checkbox"/>	PU (UNIT, SET, M)	PS*	PG
				Configurator				
				Order No.	Price per PU			

Complete units¹⁾ · Enclosure width 40 mm



Plain plunger

Plain plungers

With high-grade steel plunger

Slow-action contacts	1 NO + 1 NC --	⊕ B	B	3SE5 132-0BB01	1	1 unit	41K
Snap-action contacts	1 NO + 1 NC --	⊕ B	B	3SE5 132-0CB01	1	1 unit	41K
Slow-action contacts	1 NO + 2 NC --	⊕ B	B	3SE5 132-0KB01	1	1 unit	41K
Snap-action contacts	1 NO + 2 NC --	⊕ B	B	3SE5 132-0LB01	1	1 unit	41K
Slow-action contacts	2 NO + 1 NC --	⊕ B	B	3SE5 132-0PB01	1	1 unit	41K



Rounded plunger

Rounded plungers, type B acc. to EN 50041

With plastic plunger

Slow-action contacts	1 NO + 1 NC --	⊕ A	A	3SE5 132-0BC03	1	1 unit	41K
Snap-action contacts	1 NO + 1 NC --	⊕ A	A	3SE5 132-0CC03	1	1 unit	41K
Slow-action contacts	1 NO + 2 NC --	⊕ B	B	3SE5 132-0KC03	1	1 unit	41K
Snap-action contacts	1 NO + 2 NC --	⊕ B	B	3SE5 132-0LC03	1	1 unit	41K
Slow-action contacts	2 NO + 1 NC --	⊕ B	B	3SE5 132-0PC03	1	1 unit	41K



Roller plunger

Roller plungers, type C acc. to EN 50041

With plastic roller 13 mm

Slow-action contacts	1 NO + 1 NC --	⊕ B	B	3SE5 132-0BD05	1	1 unit	41K
Snap-action contacts	1 NO + 1 NC --	⊕ A	A	3SE5 132-0CD05	1	1 unit	41K
Slow-action contacts	1 NO + 2 NC --	⊕ B	B	3SE5 132-0KD05	1	1 unit	41K
Snap-action contacts	1 NO + 2 NC --	⊕ B	B	3SE5 132-0LD05	1	1 unit	41K
Slow-action contacts	2 NO + 1 NC --	⊕ B	B	3SE5 132-0PD05	1	1 unit	41K



Roller lever

Roller levers

With metal lever and plastic roller 22 mm

Slow-action contacts	1 NO + 1 NC --	⊕ B	B	3SE5 132-0BE05	1	1 unit	41K
Snap-action contacts	1 NO + 1 NC --	⊕ A	A	3SE5 132-0CE05	1	1 unit	41K
Slow-action contacts	1 NO + 2 NC --	⊕ B	B	3SE5 132-0KE05	1	1 unit	41K
Snap-action contacts	1 NO + 2 NC --	⊕ B	B	3SE5 132-0LE05	1	1 unit	41K
Slow-action contacts	2 NO + 1 NC --	⊕ B	B	3SE5 132-0PE05	1	1 unit	41K



Angular roller lever

Angular roller levers

With metal lever and plastic roller 22 mm

Slow-action contacts	1 NO + 1 NC --	⊕ B	B	3SE5 132-0BF05	1	1 unit	41K
Snap-action contacts	1 NO + 1 NC --	⊕ B	B	3SE5 132-0CF05	1	1 unit	41K
Snap-action contacts	1 NO + 2 NC --	⊕ B	B	3SE5 132-0LF05	1	1 unit	41K



Spring rod

Spring rods

Length 142.5 mm, with plastic plunger 50 mm

Snap-action contacts	1 NO + 1 NC --		B	3SE5 132-0CR01	1	1 unit	41K
Snap-action contacts	1 NO + 2 NC --		B	3SE5 132-0LR01	1	1 unit	41K

For online configurator see www.siemens.com/sirius/configurators.

Positive opening according to IEC 60947-5-1, Appendix K.

¹⁾ Popular versions.

SIRIUS 3SE5 Mechanical Position Switches

3SE5, plastic enclosures
Enclosure width 40 mm acc. to EN 50041

2 or 3 contacts · Degree of protection IP66/IP67 · Cable entry M20 × 1.5

Version	Contacts	LEDs	DT	Complete units	<input type="checkbox"/>	PU (UNIT, SET, M)	PS*	PG
				Configurator				
				Order No.		Price per PU		

Complete units¹⁾ · Enclosure width 40 mm



Twist lever

Twist levers, type A acc. to EN 50041

With metal lever 27 mm and plastic roller 19 mm

Slow-action contacts	1 NO + 1 NC --	⊕ A	3SE5 132-0BJ01	1	1 unit	41K
Snap-action contacts	1 NO + 1 NC --	⊕ A	3SE5 132-0CJ01	1	1 unit	41K
Slow-action contacts	1 NO + 2 NC --	⊕ B	3SE5 132-0KJ01	1	1 unit	41K
Snap-action contacts	1 NO + 2 NC --	⊕ B	3SE5 132-0LJ01	1	1 unit	41K
Slow-action contacts	2 NO + 1 NC --	⊕ B	3SE5 132-0PJ01	1	1 unit	41K

Twist levers, adjustable length

With metal lever with grid hole and plastic roller 19 mm

Snap-action contacts	1 NO + 1 NC --	⊕ B	3SE5 132-0CJ60	1	1 unit	41K
Snap-action contacts	1 NO + 2 NC --	⊕ B	3SE5 132-0LJ60	1	1 unit	41K



Twist lever,
adjustable
length, with grid
hole

With metal lever and plastic roller 19 mm

Snap-action contacts	1 NO + 1 NC --	A	3SE5 132-0CJ50	1	1 unit	41K
Snap-action contacts	1 NO + 2 NC --	B	3SE5 132-0LJ50	1	1 unit	41K



Twist lever,
adjustable
length

Rod actuators, type D, acc. to EN 50041

With aluminum rod, length 200 mm

Snap-action contacts	1 NO + 1 NC --	B	3SE5 132-0CJ80	1	1 unit	41K
----------------------	----------------	---	-----------------------	---	--------	-----

With plastic rod, length 200 mm

Snap-action contacts	1 NO + 1 NC --	A	3SE5 132-0CJ82	1	1 unit	41K
----------------------	----------------	---	-----------------------	---	--------	-----



Rod actuator

For online configurator see www.siemens.com/sirius/configurators.

⊕ Positive opening according to IEC 60947-5-1, Appendix K.

¹⁾ Popular versions.

Note:



If the device you require is not available as a complete unit, see "Modular System", page 12/20.

SIRIUS 3SE5 Mechanical Position Switches





3SE5, plastic enclosures Enclosure width 40 mm acc. to EN 50041

Modular system

2 or 3 contacts · Degree of protection IP66/IP67 · Cable entry M20 × 1.5

Version	Contacts	LEDs	DT	Modular system		PU (UNIT, SET, M)	PS*	PG
				Configurator				
				Order No.	Price per PU			

Basic switches · Enclosure width 40 mm

	With M20 × 1.5 connecting thread							
	Slow-action contacts	1 NO + 1 NC --	⊕ B	3SE5 132-0BA00		1	1 unit	41K
	Snap-action contacts	1 NO + 1 NC --	⊕ A	3SE5 132-0CA00		1	1 unit	41K
	• Gold-plated contacts		⊕ B	3SE5 132-0CA00-1AC1		1	1 unit	41K
	Slow-action contacts	1 NO + 2 NC --	⊕ B	3SE5 132-0KA00		1	1 unit	41K
	Snap-action contacts	1 NO + 2 NC --	⊕ B	3SE5 132-0LA00		1	1 unit	41K
	Slow-action contacts with make-before-break	1 NO + 2 NC --	⊕ B	3SE5 132-0MA00		1	1 unit	41K
Slow-action contacts	2 NO + 1 NC --	⊕ B	3SE5 132-0PA00		1	1 unit	41K	
	With increased corrosion protection¹⁾							
	Slow-action contacts	1 NO + 1 NC --	⊕ B	3SE5 132-0BA00-1CA0		1	1 unit	41K
	Snap-action contacts	1 NO + 1 NC --	⊕ B	3SE5 132-0CA00-1CA0		1	1 unit	41K
	Slow-action contacts	1 NO + 2 NC --	⊕ B	3SE5 132-0KA00-1CA0		1	1 unit	41K
	Snap-action contacts	1 NO + 2 NC --	⊕ B	3SE5 132-0LA00-1CA0		1	1 unit	41K
	Slow-action contacts with make-before-break	1 NO + 2 NC --	⊕ B	3SE5 132-0MA00-1CA0		1	1 unit	41K
Slow-action contacts	2 NO + 1 NC --	⊕ B	3SE5 132-0PA00-1CA0		1	1 unit	41K	
	With M12 connector socket, 4-pole (250 V, 4 A)							
	Slow-action contacts	1 NO + 1 NC --	⊕ B	3SE5 134-0BA00-1AC4		1	1 unit	41K
	Snap-action contacts	1 NO + 1 NC --	⊕ B	3SE5 134-0CA00-1AC4		1	1 unit	41K
	Slow-action contacts	2 NC --	⊕ B	3SE5 134-0KA00-1AE0		1	1 unit	41K
	Snap-action contacts	2 NC --	⊕ B	3SE5 134-0LA00-1AE0		1	1 unit	41K
	With 2 LEDs, yellow/green							
	Slow-action contacts	1 NO + 2 NC 24 V DC	⊕ C	3SE5 132-1KA00		1	1 unit	41K
	Snap-action contacts	1 NO + 2 NC 24 V DC	⊕ C	3SE5 132-1LA00		1	1 unit	41K
	Slow-action contacts	1 NO + 2 NC 230 V AC	⊕ C	3SE5 132-3KA00		1	1 unit	41K
	Snap-action contacts	1 NO + 2 NC 230 V AC	⊕ C	3SE5 132-3LA00		1	1 unit	41K

 For online configurator see www.siemens.com/sirius/configurators.

 Positive opening according to IEC 60947-5-1, Appendix K, or positively driven actuator, necessary in safety circuits.

















¹⁾ Use corresponding high-grade steel lever.

Note:

Selection aid see page 12/12.

SIRIUS 3SE5 Mechanical Position Switches

3SE5, plastic enclosures
Enclosure width 40 mm acc. to EN 50041

Version	Diameter	DT	Modular system	PU (UNIT, SET, M)	PS*	PG
	mm		Order No.	Price per PU		
Operating mechanisms						
	Plain plungers High-grade steel plungers	10	⊕ A	3SE5 000-0AB01	1	1 unit 41K
Plain plunger	Rounded plungers, type B acc. to EN 50041 Plastic plungers	10	⊕ B	3SE5 000-0AC03	1	1 unit 41K
	Roller plungers, type C acc. to EN 50041 Plastic plunger, plastic roller	13	⊕ B	3SE5 000-0AD05	1	1 unit 41K
Plunger	Plastic plunger, high-grade steel roller	13	⊕ B	3SE5 000-0AD06	1	1 unit 41K
	Roller levers Metal lever with plastic roller, plastic base	22	⊕ B	3SE5 000-0AE05	1	1 unit 41K
Roller lever	Angular roller levers Metal lever with plastic roller, plastic base	22	⊕ B	3SE5 000-0AF05	1	1 unit 41K
	Spring rods (for switches with snap-action contacts only) Plastic plunger and high-grade steel spring: • Length 142.5 mm (spring 50 mm, plunger 50 mm) • Length 76 mm (spring 23.5 mm, plunger 10 mm) • Length 242.5 mm (spring 150 mm, plunger 50 mm) High-grade steel plunger and spring: • Length 142.5 mm (spring 50 mm, plunger 50 mm)	7 7 7 7	B B B B	3SE5 000-0AR01 3SE5 000-0AR03 3SE5 000-0AR04 3SE5 000-0AR02	1 1 1 1	1 unit 41K 1 unit 41K 1 unit 41K 1 unit 41K
	Twist actuators					
	Twist actuators, plastic (without lever) • For twist levers and rod actuators, switching right and/or left, adjustable		⊕ B	3SE5 000-0AJ00	1	1 unit 41K
Twist actuator	Levers for twist actuators					
	Twist levers, offset, type A acc. to EN 50041 Metal lever 27 mm, plastic roller	19	⊕ A	3SE5 000-0AA01	1	1 unit 41K
Twist lever	Metal lever 27 mm, high-grade steel roller	19	⊕ A	3SE5 000-0AA02	1	1 unit 41K
	Metal lever 27 mm, roller with ball bearing	19	⊕ B	3SE5 000-0AA03	1	1 unit 41K
Twist lever	Metal lever 27 mm, 2 plastic rollers	19	⊕ B	3SE5 000-0AA04	1	1 unit 41K
	Metal lever 27 mm, plastic roller	30	⊕ B	3SE5 000-0AA05	1	1 unit 41K
Twist lever, adjustable length	Metal lever 27 mm, rubber roller	50	⊕ B	3SE5 000-0AA08	1	1 unit 41K
	High-grade steel lever 27 mm, plastic roller	19	⊕ B	3SE5 000-0AA11	1	1 unit 41K
Twist lever, adjustable length	High-grade steel lever 27 mm, high-grade steel roller	19	⊕ B	3SE5 000-0AA12	1	1 unit 41K
	Metal lever 35 mm, plastic roller	19	⊕ B	3SE5 000-0AA15	1	1 unit 41K
Twist lever, adjustable length	Twist levers 30 mm, straight¹⁾ Metal lever, plastic roller	19	⊕ B	3SE5 000-0AA24	1	1 unit 41K
	Metal lever, plastic roller	30	⊕ B	3SE5 000-0AA26	1	1 unit 41K
Twist lever, adjustable length	Twist levers, adjustable length, with grid hole Metal lever, plastic roller	19	⊕ B	3SE5 000-0AA60	1	1 unit 41K
	Metal lever, high-grade steel roller	19	⊕ B	3SE5 000-0AA61	1	1 unit 41K
Twist lever, adjustable length	Metal lever, rubber roller	50	⊕ B	3SE5 000-0AA68	1	1 unit 41K
	High-grade steel lever, plastic roller	19	⊕ B	3SE5 000-0AA62	1	1 unit 41K
Twist lever, adjustable length	High-grade steel lever, high-grade steel roller	19	⊕ B	3SE5 000-0AA63	1	1 unit 41K
	Twist levers, adjustable length Metal lever, plastic roller	19	A	3SE5 000-0AA50	1	1 unit 41K
Twist lever, adjustable length	Metal lever, high-grade steel roller	19	B	3SE5 000-0AA51	1	1 unit 41K
	Metal lever, plastic roller	30	B	3SE5 000-0AA55	1	1 unit 41K
Twist lever, adjustable length	Metal lever, rubber roller	50	B	3SE5 000-0AA58	1	1 unit 41K
	High-grade steel lever, plastic roller	19	B	3SE5 000-0AA52	1	1 unit 41K
Twist lever, adjustable length	High-grade steel lever, high-grade steel roller	19	B	3SE5 000-0AA53	1	1 unit 41K
	Rod actuators, type D acc. to EN 50041 Aluminum rod, length 200 mm	6	B	3SE5 000-0AA80	1	1 unit 41K
Twist lever, adjustable length	Spring rod, length 200 mm	6	B	3SE5 000-0AA81	1	1 unit 41K
	Plastic rod, length 200 mm	6	B	3SE5 000-0AA82	1	1 unit 41K
Twist lever, adjustable length						

⊕ Positively driven actuator, necessary in safety circuits.

¹⁾ Can be clinch mounted (turned through 180°, rear of lever).

* You can order this quantity or a multiple thereof.
Illustrations are approximate

SIRIUS 3SE5 Mechanical Position Switches

3SE5, plastic enclosures Enclosure width 50 mm

Selection and ordering data

Complete units

2 or 3 contacts · Degree of protection IP66/IP67 · Cable entry 2 × (M20 × 1.5)

Version	Contacts	LEDs	DT	Complete units	<input type="checkbox"/>	PU (UNIT, SET, M)	PS*	PG
				Configurator				
				Order No.		Price per PU		

Complete units¹⁾ · Enclosure width 50 mm



Rounded plunger

Rounded plungers

With teflon plunger

Slow-action contacts	1 NO + 1 NC --		⊕ A	3SE5 242-0BC05		1	1 unit	41K
Snap-action contacts	1 NO + 1 NC --		⊕ B	3SE5 242-0CC05		1	1 unit	41K
Snap-action contacts, integrated ²⁾	1 NO + 1 NC --		⊕ ►	3SE5 242-0HC05		1	1 unit	41K
Snap-action contacts • Short stroke, integrated ²⁾	1 NO + 1 NC --		⊕ B	3SE5 242-0FC05		1	1 unit	41K
Snap-action contacts • 2 × 2 mm contact gap	1 NO + 1 NC --		⊕ B	3SE5 242-0GC05		1	1 unit	41K
Slow-action contacts	1 NO + 2 NC --		⊕ B	3SE5 242-0KC05		1	1 unit	41K
Snap-action contacts	1 NO + 2 NC --		⊕ B	3SE5 242-0LC05		1	1 unit	41K
Slow-action contacts with make-before-break	1 NO + 2 NC --		⊕ A	3SE5 242-0MC05		1	1 unit	41K
Slow-action contacts	2 NO + 1 NC --		⊕ A	3SE5 242-0PC05		1	1 unit	41K



With increased corrosion protection

With increased corrosion protection

Slow-action contacts	1 NO + 1 NC --		⊕ B	3SE5 242-0BC05-1CA0		1	1 unit	41K
Snap-action contacts, integrated ²⁾	1 NO + 1 NC --		⊕ B	3SE5 242-0HC05-1CA0		1	1 unit	41K
Slow-action contacts	1 NO + 2 NC --		⊕ B	3SE5 242-0KC05-1CA0		1	1 unit	41K
Snap-action contacts	1 NO + 2 NC --		⊕ B	3SE5 242-0LC05-1CA0		1	1 unit	41K
Slow-action contacts with make-before-break	1 NO + 2 NC --		⊕ B	3SE5 242-0MC05-1CA0		1	1 unit	41K
Slow-action contacts	2 NO + 1 NC --		⊕ B	3SE5 242-0PC05-1CA0		1	1 unit	41K



With 2 LEDs

With 2 LEDs, yellow/green

Slow-action contacts	1 NO + 2 NC	24 V DC	⊕ B	3SE5 242-1KC05		1	1 unit	41K
Snap-action contacts	1 NO + 2 NC	24 V DC	⊕ B	3SE5 242-1LC05		1	1 unit	41K
Slow-action contacts	1 NO + 2 NC	230 V AC	⊕ B	3SE5 242-3KC05		1	1 unit	41K
Snap-action contacts	1 NO + 2 NC	230 V AC	⊕ B	3SE5 242-3LC05		1	1 unit	41K



Roller plunger

Roller plungers

With plastic roller 10 mm

Slow-action contacts	1 NO + 1 NC --		⊕ B	3SE5 242-0BD03		1	1 unit	41K
Snap-action contacts, integrated ²⁾	1 NO + 1 NC --		⊕ B	3SE5 242-0HD03		1	1 unit	41K
Snap-action contacts	1 NO + 2 NC --		⊕ B	3SE5 242-0LD03		1	1 unit	41K

For online configurator see www.siemens.com/sirius/configurators.

⊕ Positive opening according to IEC 60947-5-1, Appendix K.

¹⁾ Popular versions.

²⁾ Subsequent replacement of contact blocks is not possible.

SIRIUS 3SE5 Mechanical Position Switches

3SE5, plastic enclosures
Enclosure width 50 mm

2 or 3 contacts · Degree of protection IP66/IP67 · Cable entry 2 × (M20 × 1.5)

Version	Contacts	LEDs	DT	Complete units	<input type="checkbox"/>	PU (UNIT, SET, M)	PS*	PG
				Configurator				
				Order No.		Price per PU		

Complete units¹⁾ · Enclosure width 50 mm



Roller lever

Roller levers

With metal lever and plastic roller 13 mm

Slow-action contacts	1 NO + 1 NC --		⊕ B	3SE5 242-0BE10		1	1 unit	41K
Snap-action contacts, integrated ²⁾	1 NO + 1 NC --		⊕ A	3SE5 242-0HE10		1	1 unit	41K
Snap-action contacts	1 NO + 2 NC --		⊕ B	3SE5 242-0LE10		1	1 unit	41K

With M12 connector socket, 4-pole right (250 V, 4 A)

Snap-action contacts	2 NC --		⊕ B	3SE5 244-0LE10-1AE0		1	1 unit	41K
----------------------	---------	--	-----	----------------------------	--	---	--------	-----



Twist lever

Twist levers

With metal lever 21 mm and plastic roller 19 mm

Slow-action contacts	1 NO + 1 NC --		⊕ B	3SE5 242-0BK21		1	1 unit	41K
Snap-action contacts, integrated ²⁾	1 NO + 1 NC --		⊕ B	3SE5 242-0HK21		1	1 unit	41K
Snap-action contacts	1 NO + 2 NC --		⊕ B	3SE5 242-0LK21		1	1 unit	41K

Twist levers, adjustable length

With metal lever and plastic roller 19 mm

Snap-action contacts, integrated ²⁾	1 NO + 1 NC --		B	3SE5 242-0HK50		1	1 unit	41K
--	----------------	--	---	-----------------------	--	---	--------	-----



Twist lever,
adjustable
length

For online configurator see www.siemens.com/sirius/configurators.

⊕ Positive opening according to IEC 60947-5-1, Appendix K.

¹⁾ Popular versions.

²⁾ Subsequent replacement of contact blocks is not possible.

Note:

If the device you require is not available as a complete unit, see "Modular System", page 12/24.

SIRIUS 3SE5 Mechanical Position Switches

3SE5, plastic enclosures Enclosure width 50 mm

Modular system

2 or 3 contacts · Degree of protection IP66/IP67 · Cable entry 2 × (M20 × 1.5)

Version	Contacts	LEDs	DT	Modular system	PU (UNIT, SET, M)	PS*	PG
				Order No.	Price per PU		

Basic switches · Enclosure width 50 mm (with rounded plunger¹⁾)

	With teflon plunger						
	Slow-action contacts	1 NO + 1 NC --	⊕ A	3SE5 242-0BC05	1	1 unit	41K
	Snap-action contacts	1 NO + 1 NC --	⊕ B	3SE5 242-0CC05	1	1 unit	41K
	Snap-action contacts, integrated ²⁾	1 NO + 1 NC --	⊕ ▶	3SE5 242-0HC05	1	1 unit	41K
	Snap-action contacts • Short stroke, integrated ²⁾	1 NO + 1 NC --	⊕ B	3SE5 242-0FC05	1	1 unit	41K
	Snap-action contacts • 2 × 2 mm contact gap	1 NO + 1 NC --	⊕ B	3SE5 242-0GC05	1	1 unit	41K
	Slow-action contacts	1 NO + 2 NC --	⊕ B	3SE5 242-0KC05	1	1 unit	41K
	Snap-action contacts	1 NO + 2 NC --	⊕ B	3SE5 242-0LC05	1	1 unit	41K
	Slow-action contacts with make-before-break	1 NO + 2 NC --	⊕ A	3SE5 242-0MC05	1	1 unit	41K
Slow-action contacts	2 NO + 1 NC --	⊕ A	3SE5 242-0PC05	1	1 unit	41K	
	With increased corrosion protection³⁾						
	Slow-action contacts	1 NO + 1 NC --	⊕ B	3SE5 242-0BC05-1CA0	1	1 unit	41K
	Snap-action contacts, integrated ²⁾	1 NO + 1 NC --	⊕ B	3SE5 242-0HC05-1CA0	1	1 unit	41K
	Slow-action contacts	1 NO + 2 NC --	⊕ B	3SE5 242-0KC05-1CA0	1	1 unit	41K
	Snap-action contacts	1 NO + 2 NC --	⊕ B	3SE5 242-0LC05-1CA0	1	1 unit	41K
Slow-action contacts with make-before-break	1 NO + 2 NC --	⊕ B	3SE5 242-0MC05-1CA0	1	1 unit	41K	
Slow-action contacts	2 NO + 1 NC --	⊕ B	3SE5 242-0PC05-1CA0	1	1 unit	41K	
	With 2 LEDs, yellow/green						
	Slow-action contacts	1 NO + 2 NC 24 V DC	⊕ B	3SE5 242-1KC05	1	1 unit	41K
	Snap-action contacts	1 NO + 2 NC 24 V DC	⊕ B	3SE5 242-1LC05	1	1 unit	41K
	Slow-action contacts	1 NO + 2 NC 230 V AC	⊕ B	3SE5 242-3KC05	1	1 unit	41K
Slow-action contacts	1 NO + 2 NC 230 V AC	⊕ B	3SE5 242-3LC05	1	1 unit	41K	

For online configurator see www.siemens.com/sirius/configurators.

⊕ Positive opening according to IEC 60947-5-1, Appendix K, or positively driven actuator, necessary in safety circuits.

¹⁾ For enclosures with widths of 50 mm, the basic switch is a complete unit with rounded plungers.

²⁾ Subsequent replacement of contact blocks is not possible.

³⁾ Use corresponding high-grade steel lever.

Note:

Selection aid see page 12/12.

Version	Diameter	DT	Modular system	PU (UNIT, SET, M)	PS*	PG
	mm					
			Order No.	Price per PU		







Operating mechanisms

	Roller plungers, type C acc. to EN 50047					
	Plastic rollers	10	⊕ A	3SE5 000-0AD03	1	1 unit
High-grade steel rollers	10	⊕ B	3SE5 000-0AD04	1	1 unit	41K
	Roller plungers with central fixing					
	Plastic rollers	10	⊕ B	3SE5 000-0AD10	1	1 unit
High-grade steel rollers	10	⊕ B	3SE5 000-0AD11	1	1 unit	41K

⊕ Positively driven actuator, necessary in safety circuits.

SIRIUS 3SE5 Mechanical Position Switches

3SE5, plastic enclosures
Enclosure width 50 mm

Version	Diameter	DT	Modular system	PU (UNIT, SET, M)	PS*	PG	
	mm		Order No.	Price per PU			
Operating mechanisms							
	Roller levers, type E acc. to EN 50047						
	Metal lever, plastic roller	13	⊕ A	3SE5 000-0AE10	1	1 unit 41K	
	Metal lever, high-grade steel roller	13	⊕ B	3SE5 000-0AE11	1	1 unit 41K	
	High-grade steel lever, plastic roller	13	⊕ B	3SE5 000-0AE12	1	1 unit 41K	
	Angular roller levers						
	Metal lever, plastic roller	13	⊕ A	3SE5 000-0AF10	1	1 unit 41K	
	Metal lever, high-grade steel roller	13	⊕ B	3SE5 000-0AF11	1	1 unit 41K	
	High-grade steel lever, plastic roller	13	⊕ A	3SE5 000-0AF12	1	1 unit 41K	
	Spring rods (for switches with snap-action contacts only)						
	Plastic plunger and high-grade steel spring:	7					
	• Length 142.5 mm (spring 50 mm, plunger 50 mm)		B	3SE5 000-0AR01	1	1 unit 41K	
	• Length 76 mm (spring 23.5 mm, plunger 10 mm)		B	3SE5 000-0AR03	1	1 unit 41K	
	• Length 242.5 mm (spring 150 mm, plunger 50 mm)		B	3SE5 000-0AR04	1	1 unit 41K	
	High-grade steel plunger and spring:	7					
	• Length 142.5 mm (spring 50 mm, plunger 50 mm)		B	3SE5 000-0AR02	1	1 unit 41K	
Twist actuators							
	Twist actuators, plastic (without lever)						
	Switching right and/or left, adjustable		⊕ A	3SE5 000-0AK00	1	1 unit 41K	
	Levers for twist actuators						
	Twist levers 21 mm, straight, type A acc. to EN 50047						
	Metal lever, plastic roller	19	⊕ A	3SE5 000-0AA21	1	1 unit 41K	
	Metal lever, high-grade steel roller	19	⊕ B	3SE5 000-0AA22	1	1 unit 41K	
	Metal lever, roller with ball bearing	19	⊕ B	3SE5 000-0AA23	1	1 unit 41K	
	Metal lever, plastic roller	30	⊕ B	3SE5 000-0AA25	1	1 unit 41K	
	High-grade steel lever, plastic roller	19	⊕ B	3SE5 000-0AA31	1	1 unit 41K	
High-grade steel lever, high-grade steel roller	19	⊕ B	3SE5 000-0AA32	1	1 unit 41K		
	Twist levers 30 mm, straight¹⁾						
	Metal lever, plastic roller	19	⊕ B	3SE5 000-0AA24	1	1 unit 41K	
	Metal lever, plastic roller	30	⊕ B	3SE5 000-0AA26	1	1 unit 41K	
	Twist levers, adjustable length, with grid hole						
	Metal lever, plastic roller	19	⊕ B	3SE5 000-0AA60	1	1 unit 41K	
	Metal lever, high-grade steel roller	19	⊕ B	3SE5 000-0AA61	1	1 unit 41K	
Metal lever, plastic roller	50	⊕ B	3SE5 000-0AA67	1	1 unit 41K		
Metal lever, rubber roller	50	⊕ B	3SE5 000-0AA68	1	1 unit 41K		
High-grade steel lever, plastic roller	19	⊕ B	3SE5 000-0AA62	1	1 unit 41K		
High-grade steel lever, high-grade steel roller	19	⊕ B	3SE5 000-0AA63	1	1 unit 41K		
	Twist levers, adjustable length						
	Metal lever, plastic roller	19	A	3SE5 000-0AA50	1	1 unit 41K	
	Metal lever, high-grade steel roller	19	B	3SE5 000-0AA51	1	1 unit 41K	
	Metal lever, plastic roller	30	B	3SE5 000-0AA55	1	1 unit 41K	
	Metal lever, plastic roller	50	B	3SE5 000-0AA57	1	1 unit 41K	
	Metal lever, rubber roller	50	B	3SE5 000-0AA58	1	1 unit 41K	
	High-grade steel lever, plastic roller	19	B	3SE5 000-0AA52	1	1 unit 41K	
	High-grade steel lever, high-grade steel roller	19	B	3SE5 000-0AA53	1	1 unit 41K	
Rod actuators							
Aluminum rod, length 200 mm	6	B	3SE5 000-0AA80	1	1 unit 41K		
Spring rod, length 200 mm	6	B	3SE5 000-0AA81	1	1 unit 41K		
Plastic rod, length 200 mm	6	B	3SE5 000-0AA82	1	1 unit 41K		

⊕ Positively driven actuator, necessary in safety circuits.

¹⁾ Can be clinch mounted (turned through 180°, rear of lever).

SIRIUS 3SE5 Mechanical Position Switches

3SE5, plastic enclosures
Ambient temperature to $-40\text{ }^{\circ}\text{C}$

Selection and ordering data

Complete units

2 or 3 contacts · Degree of protection IP65 or IP66/IP67 · Cable entry M20 × 1.5

Version	Contacts	LEDs	DT	Complete units	<input type="checkbox"/>	PU (UNIT, SET, M)	PS*	PG
				Configurator				
				Order No.		Price per PU		

Complete units¹⁾ · Enclosure width 31 mm



Roller plunger
with central
fixing

Roller plungers with central fixing

Snap-action contacts 1 NO + 1 NC -- B **3SE5 232-0CD10-1AJ0** 1 1 unit 41K



Twist lever

Twist levers, type A acc. to EN 50047

With high-grade steel lever 21 mm and plastic roller 19 mm

Snap-action contacts 1 NO + 1 NC -- A **3SE5 232-0CK31-1AJ0** 1 1 unit 41K



Twist lever,
adjustable
length

Twist levers, adjustable length

With high-grade steel lever with grid hole
and plastic roller 19 mm

Snap-action contacts 1 NO + 1 NC -- A **3SE5 232-0CK62-1AJ0** 1 1 unit 41K

Snap-action contacts 1 NO + 2 NC -- B **3SE5 232-0LK62-1AJ0** 1 1 unit 41K

Complete units¹⁾ · Enclosure width 50 mm

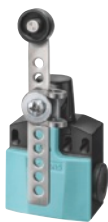

Twist lever,
adjustable
length

Twist levers

With metal lever 21 mm and plastic roller 19 mm

Snap-action contacts, integrated²⁾ 1 NO + 1 NC -- B **3SE5 242-0HK21-1AJ0** 1 1 unit 41K

Twist levers, adjustable length

With high-grade steel lever with grid hole and plastic roller
19 mm

Snap-action contacts, integrated²⁾ 1 NO + 1 NC -- B **3SE5 242-0HK62-1AJ0** 1 1 unit 41K

For online configurator see www.siemens.com/sirius/configurators.

Positive opening according to IEC 60947-5-1, Appendix K, or positively driven actuator, necessary in safety circuits.

1) Popular versions.

2) Subsequent replacement of contact blocks is not possible.

Note:









If the device you require is not available as a complete unit, see "Modular System", page 12/27.

SIRIUS 3SE5 Mechanical Position Switches

3SE5, plastic enclosures
Ambient temperature to -40 °C

Modular system

2 or 3 contacts · Degree of protection IP65 or IP66/IP67 · Cable entry M20 × 1.5

Version	Contacts	LEDs	DT	Modular system	PU (UNIT, SET, M)	PS*	PG
							
							
				Order No.	Price per PU		
Basic switches • Enclosure width 31 mm (with rounded plunger¹⁾)							
	With teflon plunger						
	Snap-action contacts	1 NO + 1 NC --	 B	3SE5 232-0CC05-1AJ0	1	1 unit	41K
	Slow-action contacts	1 NO + 2 NC --	 B	3SE5 232-0KC05-1AJ0	1	1 unit	41K
	Snap-action contacts	1 NO + 2 NC --	 B	3SE5 232-0LC05-1AJ0	1	1 unit	41K
Basic switches • Enclosure width 50 mm (with rounded plunger¹⁾)							
	With teflon plunger						
	Slow-action contacts	1 NO + 1 NC --	 B	3SE5 242-0BC05-1AJ0	1	1 unit	41K
	Snap-action contacts, integrated ²⁾	1 NO + 1 NC --	 B	3SE5 242-0HC05-1AJ0	1	1 unit	41K

Basic switch

Basic switch

 For online configurator see www.siemens.com/sirius/configurators.

 Positive opening according to IEC 60947-5-1, Appendix K, or positively driven actuator, necessary in safety circuits.

¹⁾ For enclosures with widths of 31 and 50 mm, the basic switch is a complete unit with rounded plungers.







²⁾ Subsequent replacement of contact blocks is not possible.

Note:

Selection aid [see page 12/12](#).

SIRIUS 3SE5 Mechanical Position Switches

3SE5, plastic enclosures
Ambient temperature to -40 °C

Version	Diameter	DT	Modular system	PU (UNIT, SET, M)	PS*	PG
	mm		Order No.	Price per PU		
Operating mechanisms						
	Roller plungers, type C acc. to EN 50047					
Roller plunger	Plastic rollers	10	⊕ B	3SE5 000-0AD03-1AJ0	1	1 unit 41K
	Roller levers, type E acc. to EN 50047					
Roller lever	Metal lever, plastic roller	13	⊕ B	3SE5 000-0AE10-1AJ0	1	1 unit 41K
	High-grade steel lever, plastic roller	13	⊕ B	3SE5 000-0AE12-1AJ0	1	1 unit 41K
	Angular roller levers					
Angular roller lever	Metal lever, plastic roller	13	⊕ B	3SE5 000-0AF10-1AJ0	1	1 unit 41K
	High-grade steel lever, plastic roller	13	⊕ B	3SE5 000-0AF12-1AJ0	1	1 unit 41K
Twist actuators						
	Twist actuators, plastic (without lever)					
Twist actuator	Switching right and/or left, adjustable		⊕ B	3SE5 000-0AK00-1AJ0	1	1 unit 41K
	Levers for twist actuators					
Twist lever	Twist levers straight, 21 mm, type A acc. to EN 50047					
	Metal lever, plastic roller	19	⊕ B	3SE5 000-0AA21-1AJ0	1	1 unit 41K
	High-grade steel lever, plastic roller	19	⊕ B	3SE5 000-0AA31-1AJ0	1	1 unit 41K
	Twist levers, adjustable length, with grid hole					
Twist lever, adjustable length	Metal lever, plastic roller	19	⊕ B	3SE5 000-0AA60-1AJ0	1	1 unit 41K
	High-grade steel lever, plastic roller	19	⊕ B	3SE5 000-0AA62-1AJ0	1	1 unit 41K

⊕ Positively driven actuator, necessary in safety circuits.

3SE5, plastic enclosures
Ambient temperature to **-40 °C**

Modular system

2 or 3 contacts · Degree of protection IP66/IP67 · Cable entry M20 × 1.5

Version	Contacts	LEDs	DT	Modular system	PU (UNIT, SET, M)	PS*	PG
				Configurator			
				Order No.	Price per PU		

Basic switches · Enclosure width 40 mm

Basic switch

With M20 × 1.5 connecting thread

Snap-action contacts	1 NO + 1 NC --		B	3SE5 132-0CA00-1AJ0	1	1 unit	41K
Slow-action contacts	1 NO + 2 NC --		B	3SE5 132-0KA00-1AJ0	1	1 unit	41K
Snap-action contacts	1 NO + 2 NC --		B	3SE5 132-0LA00-1AJ0	1	1 unit	41K

For online configurator see www.siemens.com/sirius/configurators .

Positive opening according to IEC 60947-5-1, Appendix K, or positively driven actuator, necessary in safety circuits.

Note:

Selection aid see page 12/12.

Version	Diameter	DT	Modular system	PU (UNIT, SET, M)	PS*	PG
	mm					
			Order No.	Price per PU		

Operating mechanisms

Rounded plunger

Rounded plungers, type B acc. to EN 50041

Plastic plunger	10		B	3SE5 000-0AC03-1AJ0	1	1 unit	41K
-----------------	----	--	---	----------------------------	---	--------	-----



Roller plunger

Roller plungers, type C acc. to EN 50041

Plastic plunger, plastic roller	13		B	3SE5 000-0AD05-1AJ0	1	1 unit	41K
---------------------------------	----	--	---	----------------------------	---	--------	-----



Roller lever

Roller levers

Metal lever with plastic roller, plastic base	22		B	3SE5 000-0AE05-1AJ0	1	1 unit	41K
---	----	--	---	----------------------------	---	--------	-----

Twist actuators

Twist actuator

Twist actuators, plastic (without lever)

• For twist levers and rod actuators, switching right and/or left, adjustable			B	3SE5 000-0AJ00-1AJ0	1	1 unit	41K
---	--	--	---	----------------------------	---	--------	-----



Twist levers

Levers for twist actuators**Twist lever, type A acc. to EN 50041**

Metal lever, plastic roller	19		B	3SE5 000-0AA01-1AJ0	1	1 unit	41K
High-grade steel lever, plastic roller	19		B	3SE5 000-0AA11-1AJ0	1	1 unit	41K



Twist lever, adjustable length

Twist levers, adjustable length, with grid hole

Metal lever, plastic roller	19		B	3SE5 000-0AA60-1AJ0	1	1 unit	41K
High-grade steel lever, plastic roller	19		B	3SE5 000-0AA62-1AJ0	1	1 unit	41K

Positively driven actuator, necessary in safety circuits.

SIRIUS 3SE5 Mechanical Position Switches

3SE5, metal enclosures Enclosure width 31 mm acc. to EN 50047





Selection and ordering data

Complete units

2 or 3 contacts · Degree of protection IP66/IP67 · Cable entry M20 × 1.5

Version	Contacts	LEDs	DT	Complete units	<input type="checkbox"/>	PU (UNIT, SET, M)	PS*	PG
				Configurator				
				Order No.		Price per PU		

Complete units¹⁾ · Enclosure width 31 mm

 Rounded plunger	Rounded plungers, type B, acc. to EN 50047							
	With plunger							
	Slow-action contacts	1 NO + 1 NC --		⊕ A	3SE5 212-0BC05		1	1 unit 41K
	Snap-action contacts	1 NO + 1 NC --		⊕ A	3SE5 212-0CC05		1	1 unit 41K
	Slow-action contacts	1 NO + 2 NC --		⊕ A	3SE5 212-0KC05		1	1 unit 41K
	Snap-action contacts	1 NO + 2 NC --		⊕ A	3SE5 212-0LC05		1	1 unit 41K
	Slow-action contacts with make-before-break	1 NO + 2 NC --		⊕ A	3SE5 212-0MC05		1	1 unit 41K
Slow-action contacts	2 NO + 1 NC --		⊕ A	3SE5 212-0PC05		1	1 unit 41K	
 With increased corrosion protection	With increased corrosion protection							
	Slow-action contacts	1 NO + 1 NC --		⊕ B	3SE5 212-0BC05-1CA0		1	1 unit 41K
	Snap-action contacts	1 NO + 1 NC --		⊕ B	3SE5 212-0CC05-1CA0		1	1 unit 41K
	Slow-action contacts	1 NO + 2 NC --		⊕ B	3SE5 212-0KC05-1CA0		1	1 unit 41K
	Snap-action contacts	1 NO + 2 NC --		⊕ B	3SE5 212-0LC05-1CA0		1	1 unit 41K
	Slow-action contacts with make-before-break	1 NO + 2 NC --		⊕ B	3SE5 212-0MC05-1CA0		1	1 unit 41K
	Slow-action contacts	2 NO + 1 NC --		⊕ B	3SE5 212-0PC05-1CA0		1	1 unit 41K
 With 2 LEDs	With M12 connector socket, 5-pole (125 V, 4 A)							
	Slow-action contacts	1 NO + 1 NC --		⊕ B	3SE5 214-0BC05-1AC5		1	1 unit 41K
	Snap-action contacts	1 NO + 1 NC --		⊕ B	3SE5 214-0CC05-1AC5		1	1 unit 41K
	Slow-action contacts	2 NC --		⊕ B	3SE5 214-0KC05-1AE1		1	1 unit 41K
	Snap-action contacts	2 NC --		⊕ B	3SE5 214-0LC05-1AE1		1	1 unit 41K
	With 2 LEDs, yellow/green							
	Slow-action contacts	1 NO + 2 NC 24 V DC		⊕ B	3SE5 212-1KC05		1	1 unit 41K
Snap-action contacts	1 NO + 2 NC 24 V DC		⊕ A	3SE5 212-1LC05		1	1 unit 41K	
Slow-action contacts	1 NO + 2 NC 230 V AC		⊕ B	3SE5 212-3KC05		1	1 unit 41K	
Snap-action contacts	1 NO + 2 NC 230 V AC		⊕ B	3SE5 212-3LC05		1	1 unit 41K	
 Plain plunger	With M12 connector socket, 5-pole (125 V, 4 A) and 2 LEDs							
	Slow-action contacts	1 NO + 1 NC 24 V DC		⊕ B	3SE5 214-1BC05-1AF3		1	1 unit 41K
	Snap-action contacts	1 NO + 1 NC 24 V DC		⊕ B	3SE5 214-1CC05-1AF3		1	1 unit 41K
	Plain plungers							
	With high-grade steel plunger							
	Slow-action contacts	1 NO + 1 NC --		⊕ B	3SE5 212-0BB01		1	1 unit 41K
	Snap-action contacts	1 NO + 1 NC --		⊕ B	3SE5 212-0CB01		1	1 unit 41K
Slow-action contacts	1 NO + 2 NC --		⊕ B	3SE5 212-0KB01		1	1 unit 41K	
Snap-action contacts	1 NO + 2 NC --		⊕ B	3SE5 212-0LB01		1	1 unit 41K	
 Roller plunger	Roller plungers, type C acc. to EN 50047							
	With plastic roller 10 mm							
	Slow-action contacts	1 NO + 1 NC --		⊕ A	3SE5 212-0BD03		1	1 unit 41K
	Snap-action contacts	1 NO + 1 NC --		⊕ B	3SE5 212-0CD03		1	1 unit 41K
	Slow-action contacts	1 NO + 2 NC --		⊕ A	3SE5 212-0KD03		1	1 unit 41K
	Snap-action contacts	1 NO + 2 NC --		⊕ B	3SE5 212-0LD03		1	1 unit 41K

For online configurator see www.siemens.com/sirius/configurators.

⊕ Positive opening according to IEC 60947-5-1, Appendix K.

¹⁾ Popular versions.

SIRIUS 3SE5 Mechanical Position Switches

3SE5, metal enclosures
Enclosure width 31 mm acc. to EN 50047

2 or 3 contacts · Degree of protection IP66/IP67 · Cable entry M20 × 1.5

Version	Contacts	LEDs	DT	Complete units	<input type="checkbox"/>	PU (UNIT, SET, M)	PS*	PG
				Configurator				
				Order No.	Price per PU			

Complete units¹⁾ • Enclosure width 31 mm



Roller lever

Roller levers, type E acc. to EN 50047

With metal lever and plastic roller 13 mm

Slow-action contacts	1 NO + 1 NC --	⊕ A	3SE5 212-0BE10	1	1 unit	41K
Snap-action contacts	1 NO + 1 NC --	⊕ B	3SE5 212-0CE10	1	1 unit	41K
Slow-action contacts	1 NO + 2 NC --	⊕ B	3SE5 212-0KE10	1	1 unit	41K
Snap-action contacts	1 NO + 2 NC --	⊕ B	3SE5 212-0LE10	1	1 unit	41K



Angular roller lever

Angular roller levers

With metal lever and plastic roller 13 mm

Slow-action contacts	1 NO + 1 NC --	⊕ B	3SE5 212-0BF10	1	1 unit	41K
Snap-action contacts	1 NO + 1 NC --	⊕ B	3SE5 212-0CF10	1	1 unit	41K
Slow-action contacts	1 NO + 2 NC --	⊕ B	3SE5 212-0KF10	1	1 unit	41K
Snap-action contacts	1 NO + 2 NC --	⊕ B	3SE5 212-0LF10	1	1 unit	41K



Twist lever

Twist levers, type A acc. to EN 50047

With metal lever 21 mm and plastic roller 19 mm

Slow-action contacts	1 NO + 1 NC --	⊕ A	3SE5 212-0BK21	1	1 unit	41K
Snap-action contacts	1 NO + 1 NC --	⊕ A	3SE5 212-0CK21	1	1 unit	41K
Slow-action contacts	1 NO + 2 NC --	⊕ B	3SE5 212-0KK21	1	1 unit	41K
Snap-action contacts	1 NO + 2 NC --	⊕ B	3SE5 212-0LK21	1	1 unit	41K



Twist lever, adjustable length

Twist levers, adjustable length

With metal lever with grid hole and plastic roller 19 mm

Snap-action contacts	1 NO + 1 NC --	⊕ A	3SE5 212-0CK60	1	1 unit	41K
Slow-action contacts	1 NO + 2 NC --	⊕ B	3SE5 212-0KK60	1	1 unit	41K
Snap-action contacts	1 NO + 2 NC --	⊕ B	3SE5 212-0LK60	1	1 unit	41K

With metal lever and plastic roller 19 mm

Slow-action contacts	1 NO + 1 NC --	A	3SE5 212-0BK50	1	1 unit	41K
Snap-action contacts	1 NO + 1 NC --	B	3SE5 212-0CK50	1	1 unit	41K
Snap-action contacts	1 NO + 2 NC --	B	3SE5 212-0LK50	1	1 unit	41K

For online configurator see www.siemens.com/sirius/configurators.

⊕ Positive opening according to IEC 60947-5-1, Appendix K.

¹⁾ Popular versions.

Note:

If the device you require is not available as a complete unit, see "Modular System", page 12/32.

SIRIUS 3SE5 Mechanical Position Switches

3SE5, metal enclosures Enclosure width 31 mm acc. to EN 50047

Modular system

2 or 3 contacts · Degree of protection IP66/IP67 · Cable entry M20 × 1.5

Version	Contacts	LEDs	DT	Modular system	PU (UNIT, SET, M)	PS*	PG
				Configurator			
				Order No.	Price per PU		

Basic switches · Enclosure width 31 mm (with rounded plunger¹⁾)

	With plunger						
	Slow-action contacts	1 NO + 1 NC --	⊕ A	3SE5 212-0BC05	1	1 unit	41K
	Snap-action contacts	1 NO + 1 NC --	⊕ A	3SE5 212-0CC05	1	1 unit	41K
	Slow-action contacts	1 NO + 2 NC --	⊕ A	3SE5 212-0KC05	1	1 unit	41K
	Snap-action contacts	1 NO + 2 NC --	⊕ A	3SE5 212-0LC05	1	1 unit	41K
	Slow-action contacts with make-before-break	1 NO + 2 NC --	⊕ A	3SE5 212-0MC05	1	1 unit	41K
	Slow-action contacts	2 NO + 1 NC --	⊕ A	3SE5 212-0PC05	1	1 unit	41K
	With increased corrosion protection²⁾						
	Slow-action contacts	1 NO + 1 NC --	⊕ B	3SE5 212-0BC05-1CA0	1	1 unit	41K
	Snap-action contacts	1 NO + 1 NC --	⊕ B	3SE5 212-0CC05-1CA0	1	1 unit	41K
	Slow-action contacts	1 NO + 2 NC --	⊕ B	3SE5 212-0KC05-1CA0	1	1 unit	41K
	Snap-action contacts	1 NO + 2 NC --	⊕ B	3SE5 212-0LC05-1CA0	1	1 unit	41K
	Slow-action contacts with make-before-break	1 NO + 2 NC --	⊕ B	3SE5 212-0MC05-1CA0	1	1 unit	41K
	Slow-action contacts	2 NO + 1 NC --	⊕ B	3SE5 212-0PC05-1CA0	1	1 unit	41K
	With M12 connector socket, 5-pole (125 V, 4 A)						
	Slow-action contacts	1 NO + 1 NC --	⊕ B	3SE5 214-0BC05-1AC5	1	1 unit	41K
	Snap-action contacts	1 NO + 1 NC --	⊕ B	3SE5 214-0CC05-1AC5	1	1 unit	41K
	Slow-action contacts	2 NC --	⊕ B	3SE5 214-0KC05-1AE1	1	1 unit	41K
	Snap-action contacts	2 NC --	⊕ B	3SE5 214-0LC05-1AE1	1	1 unit	41K
	With 2 LEDs, yellow/green						
	Slow-action contacts	1 NO + 2 NC 24 V DC	⊕ B	3SE5 212-1KC05	1	1 unit	41K
	Snap-action contacts	1 NO + 2 NC 24 V DC	⊕ A	3SE5 212-1LC05	1	1 unit	41K
	Slow-action contacts	1 NO + 2 NC 230 V AC	⊕ B	3SE5 212-3KC05	1	1 unit	41K
	Snap-action contacts	1 NO + 2 NC 230 V AC	⊕ B	3SE5 212-3LC05	1	1 unit	41K
	With M12 connector socket, 5-pole (125 V, 4 A) and 2 LEDs						
	Slow-action contacts	1 NO + 1 NC 24 V DC	⊕ B	3SE5 214-1BC05-1AF3	1	1 unit	41K
	Snap-action contacts	1 NO + 1 NC 24 V DC	⊕ B	3SE5 214-1CC05-1AF3	1	1 unit	41K

For online configurator see www.siemens.com/sirius/configurators.

⊕ Positive opening according to IEC 60947-5-1, Appendix K, or positively driven actuator, necessary in safety circuits.

¹⁾ For enclosures with widths of 31mm, the basic switch is a complete unit with rounded plungers.

²⁾ Use corresponding high-grade steel lever.

Note:

Selection aid see page 12/12.

Version	Diameter	DT	Modular system	PU (UNIT, SET, M)	PS*	PG
	mm		Order No.	Price per PU		











Operating mechanisms

	Plain plungers						
	High-grade steel plungers	10	⊕ A	3SE5 000-0AB01	1	1 unit	41K
	Roller plungers, type C acc. to EN 50047						
	Plastic rollers	10	⊕ A	3SE5 000-0AD03	1	1 unit	41K
	High-grade steel rollers	10	⊕ B	3SE5 000-0AD04	1	1 unit	41K

⊕ Positively driven actuator, necessary in safety circuits.

SIRIUS 3SE5 Mechanical Position Switches

3SE5, metal enclosures
Enclosure width 31 mm acc. to EN 50047

Version	Diameter	DT	Modular system	PU (UNIT, SET, M)	PS*	PG	
	mm		Order No.	Price per PU			
Operating mechanisms							
	Roller plungers with central fixing						
	Plastic rollers	10	⊕ B	3SE5 000-0AD10	1	1 unit	41K
	High-grade steel rollers	10	⊕ B	3SE5 000-0AD11	1	1 unit	41K
With central fixing							
	Roller levers, type E acc. to EN 50047						
	Metal lever, plastic roller	13	⊕ A	3SE5 000-0AE10	1	1 unit	41K
	Metal lever, high-grade steel roller	13	⊕ B	3SE5 000-0AE11	1	1 unit	41K
	High-grade steel lever, plastic roller	13	⊕ B	3SE5 000-0AE12	1	1 unit	41K
	High-grade steel lever, high-grade steel roller	13	⊕ B	3SE5 000-0AE13	1	1 unit	41K
Roller lever							
	Angular roller levers						
	Metal lever, plastic roller	13	⊕ A	3SE5 000-0AF10	1	1 unit	41K
	Metal lever, high-grade steel roller	13	⊕ B	3SE5 000-0AF11	1	1 unit	41K
	High-grade steel lever, plastic roller	13	⊕ A	3SE5 000-0AF12	1	1 unit	41K
	High-grade steel lever, high-grade steel roller	13	⊕ B	3SE5 000-0AF13	1	1 unit	41K
Angular roller lever							
	Spring rods (for switches with snap-action contacts only)						
	Plastic plunger and high-grade steel spring:	7					
	• Length 142.5 mm (spring 50 mm, plunger 50 mm)		B	3SE5 000-0AR01	1	1 unit	41K
	• Length 76 mm (spring 23.5 mm, plunger 10 mm)		B	3SE5 000-0AR03	1	1 unit	41K
	• Length 242.5 mm (spring 150 mm, plunger 50 mm)		B	3SE5 000-0AR04	1	1 unit	41K
High-grade steel plunger and spring:	7						
• Length 142.5 mm (spring 50 mm, plunger 50 mm)		B	3SE5 000-0AR02	1	1 unit	41K	
Spring rod							
Twist actuators							
	Twist actuators, plastic (without lever)						
	Switching right and/or left, adjustable		⊕ A	3SE5 000-0AK00	1	1 unit	41K
Twist actuator							
	Levers for twist actuators						
	Twist levers, straight, type A acc. to EN 50047						
	Metal lever 21 mm, plastic roller	19	⊕ A	3SE5 000-0AA21	1	1 unit	41K
	Metal lever 21 mm, high-grade steel roller	19	⊕ B	3SE5 000-0AA22	1	1 unit	41K
	Metal lever 21 mm, roller with ball bearing	19	⊕ B	3SE5 000-0AA23	1	1 unit	41K
	Metal lever 21 mm, plastic roller	30	⊕ B	3SE5 000-0AA25	1	1 unit	41K
	High-grade steel lever 21 mm, plastic roller	19	⊕ B	3SE5 000-0AA31	1	1 unit	41K
	High-grade steel lever 21 mm, high-grade steel roller	19	⊕ B	3SE5 000-0AA32	1	1 unit	41K
Twist levers							
	Twist levers 30 mm, straight¹⁾						
	Metal lever, plastic roller	19	⊕ B	3SE5 000-0AA24	1	1 unit	41K
	Metal lever, plastic roller	30	⊕ B	3SE5 000-0AA26	1	1 unit	41K
	Twist levers, adjustable length, with grid hole						
	Metal lever, plastic roller	19	⊕ B	3SE5 000-0AA60	1	1 unit	41K
	Metal lever, high-grade steel roller	19	⊕ B	3SE5 000-0AA61	1	1 unit	41K
	Metal lever, plastic roller	50	⊕ B	3SE5 000-0AA67	1	1 unit	41K
	Metal lever, rubber roller	50	⊕ B	3SE5 000-0AA68	1	1 unit	41K
	High-grade steel lever, plastic roller	19	⊕ B	3SE5 000-0AA62	1	1 unit	41K
	High-grade steel lever, high-grade steel roller	19	⊕ B	3SE5 000-0AA63	1	1 unit	41K
	Twist lever, adjustable length						
	Twist levers, adjustable length						
	Metal lever, plastic roller	19	A	3SE5 000-0AA50	1	1 unit	41K
	Metal lever, high-grade steel roller	19	B	3SE5 000-0AA51	1	1 unit	41K
	Metal lever, plastic roller	30	B	3SE5 000-0AA55	1	1 unit	41K
	Metal lever, plastic roller	50	B	3SE5 000-0AA57	1	1 unit	41K
	Metal lever, rubber roller	50	B	3SE5 000-0AA58	1	1 unit	41K
	High-grade steel lever, plastic roller	19	B	3SE5 000-0AA52	1	1 unit	41K
	High-grade steel lever, high-grade steel roller	19	B	3SE5 000-0AA53	1	1 unit	41K
	Twist lever, adjustable length						
	Rod actuators, type D acc. to EN 50041						
	Aluminum rod, length 200 mm	6	B	3SE5 000-0AA80	1	1 unit	41K
	Spring rod, length 200 mm	6	B	3SE5 000-0AA81	1	1 unit	41K
	Plastic rod, length 200 mm	6	B	3SE5 000-0AA82	1	1 unit	41K
	Plastic rod, length 330 mm	6	B	3SE5 000-0AA83	1	1 unit	41K
Rod actuator							

⊕ Positively driven actuator, necessary in safety circuits.

¹⁾ Can be clinch mounted (turned through 180°, rear of lever).







SIRIUS 3SE5 Mechanical Position Switches

3SE5, metal enclosures Enclosure width 40 mm acc. to EN 50041

Selection and ordering data

Complete units

2 or 3 contacts · Degree of protection IP66/IP67 · Cable entry M20 × 1.5

Version	Contacts	LEDs	DT	Complete units	<input type="checkbox"/>	PU (UNIT, SET, M)	PS*	PG
				Configurator				
				Order No.	Price per PU			
Complete units¹⁾ · Enclosure width 40 mm								
Plain plungers								
With high-grade steel plunger								
 Plain plunger	Slow-action contacts	1 NO + 1 NC --	⊕ A	3SE5 112-0BB01		1	1 unit	41K
	Snap-action contacts	1 NO + 1 NC --	⊕ A	3SE5 112-0CB01		1	1 unit	41K
	Slow-action contacts	1 NO + 2 NC --	⊕ B	3SE5 112-0KB01		1	1 unit	41K
	Snap-action contacts	1 NO + 2 NC --	⊕ B	3SE5 112-0LB01		1	1 unit	41K
Rounded plungers, type B acc. to EN 50041								
With high-grade steel plungers, with 3 mm overtravel								
 Rounded plunger	Slow-action contacts	1 NO + 1 NC --	⊕ B	3SE5 112-0BC02		1	1 unit	41K
	Snap-action contacts	1 NO + 1 NC --	⊕ ▶	3SE5 112-0CC02		1	1 unit	41K
	Slow-action contacts	1 NO + 2 NC --	⊕ B	3SE5 112-0KC02		1	1 unit	41K
	Snap-action contacts	1 NO + 2 NC --	⊕ B	3SE5 112-0LC02		1	1 unit	41K
Roller plungers, type C acc. to EN 50041								
With high-grade steel roller 13 mm, with 3 mm overtravel								
 Roller plunger	Slow-action contacts	1 NO + 1 NC --	⊕ B	3SE5 112-0BD02		1	1 unit	41K
	Snap-action contacts	1 NO + 1 NC --	⊕ ▶	3SE5 112-0CD02		1	1 unit	41K
	Slow-action contacts	1 NO + 2 NC --	⊕ B	3SE5 112-0KD02		1	1 unit	41K
	Snap-action contacts	1 NO + 2 NC --	⊕ B	3SE5 112-0LD02		1	1 unit	41K
With M12 connector socket, 5-pole (125 V, 4 A) and 2 LEDs								
	Snap-action contacts	1 NO + 1 NC 24 V DC	⊕ B	3SE5 114-1CD02-1AF3		1	1 unit	41K
Roller levers								
With metal lever and plastic roller 22 mm								
 Roller lever	Slow-action contacts	1 NO + 1 NC --	⊕ B	3SE5 112-0BE01		1	1 unit	41K
	Snap-action contacts	1 NO + 1 NC --	⊕ ▶	3SE5 112-0CE01		1	1 unit	41K
	Slow-action contacts	1 NO + 2 NC --	⊕ B	3SE5 112-0KE01		1	1 unit	41K
	Snap-action contacts	1 NO + 2 NC --	⊕ B	3SE5 112-0LE01		1	1 unit	41K
Angular roller levers								
With metal lever and plastic roller 22 mm								
 Angular roller lever	Slow-action contacts	1 NO + 1 NC --	⊕ B	3SE5 112-0BF01		1	1 unit	41K
	Snap-action contacts	1 NO + 1 NC --	⊕ A	3SE5 112-0CF01		1	1 unit	41K
	Snap-action contacts	1 NO + 2 NC --	⊕ B	3SE5 112-0LF01		1	1 unit	41K
Spring rods								
Length 142.5 mm, with plastic plunger 50 mm								
 Spring rod	Snap-action contacts	1 NO + 1 NC --	▶	3SE5 112-0CR01		1	1 unit	41K

For online configurator see www.siemens.com/sirius/configurators.

⊕ Positive opening according to IEC 60947-5-1, Appendix K.

¹⁾ Popular versions.

SIRIUS 3SE5 Mechanical Position Switches

3SE5, metal enclosures
Enclosure width 40 mm acc. to EN 50041

2 or 3 contacts · Degree of protection IP66/IP67 · Cable entry M20 × 1.5

Version	Contacts	LEDs	DT	Complete units	<input type="checkbox"/>	PU (UNIT, SET, M)	PS*	PG
				Configurator				
				Order No.		Price per PU		

Complete units¹⁾ · Enclosure width 40 mm

	Twist levers, type A acc. to EN 50041								
	With metal lever 27 mm and plastic roller 19 mm								
	Slow-action contacts	1 NO + 1 NC --	⊕	B	3SE5 112-0BH01		1	1 unit	41K
	Snap-action contacts	1 NO + 1 NC --	⊕ ▶		3SE5 112-0CH01		1	1 unit	41K
	Slow-action contacts	1 NO + 2 NC --	⊕	B	3SE5 112-0KH01		1	1 unit	41K
	Snap-action contacts	1 NO + 2 NC --	⊕	B	3SE5 112-0LH01		1	1 unit	41K
	With M12 connector socket, 5-pole (125 V, 4 A)								
	Snap-action contacts	1 NO + 1 NC --	⊕	A	3SE5 114-0CH01-1AC5		1	1 unit	41K
	With M12 connector socket, 5-pole (125 V, 4 A) and 2 LEDs								
	Snap-action contacts	1 NO + 1 NC 24 V DC	⊕	B	3SE5 114-1CH01-1AF3		1	1 unit	41K
	With metal lever 27 mm and high-grade steel roller 19 mm								
	Slow-action contacts	1 NO + 1 NC --	⊕	B	3SE5 112-0BH02		1	1 unit	41K
	Snap-action contacts	1 NO + 1 NC --	⊕	A	3SE5 112-0CH02		1	1 unit	41K
	With M12 connector socket, 5-pole (125 V, 4 A) and 2 LEDs								
	Snap-action contacts	1 NO + 1 NC --	⊕	B	3SE5 114-1CH02-1AF3		1	1 unit	41K
	With metal lever 30 mm and plastic roller 19 mm								
	Snap-action contacts	1 NO + 1 NC --	⊕ ▶		3SE5 112-0CH24		1	1 unit	41K
	Twist levers, adjustable length								
	With metal lever with grid hole and plastic roller 19 mm								
	Slow-action contacts	1 NO + 1 NC --	⊕	B	3SE5 112-0BH60		1	1 unit	41K
	Snap-action contacts	1 NO + 1 NC --	⊕ ▶		3SE5 112-0CH60		1	1 unit	41K
	Snap-action contacts	1 NO + 2 NC --	⊕	B	3SE5 112-0LH60		1	1 unit	41K
	With metal lever and plastic roller 19 mm								
	Slow-action contacts	1 NO + 1 NC --		B	3SE5 112-0BH50		1	1 unit	41K
	Snap-action contacts	1 NO + 1 NC --		▶	3SE5 112-0CH50		1	1 unit	41K
	Snap-action contacts	1 NO + 2 NC --		B	3SE5 112-0LH50		1	1 unit	41K
	With M12 connector socket, 8-pole (30 V, 2 A) and 2 LEDs								
	Snap-action contacts	1 NO + 2 NC 24 V DC		B	3SE5 114-1LH50-1AD4		1	1 unit	41K
	With metal lever and high-grade steel roller 19 mm								
	Snap-action contacts	1 NO + 1 NC --		B	3SE5 112-0CH51		1	1 unit	41K
	Fork levers, latching								
	With metal lever and 2 plastic rollers 19 mm								
	Snap-action contacts	1 NO + 1 NC --	⊕	B	3SE5 112-0CT11		1	1 unit	41K
	Rod actuators, type D, acc. to EN 50041								
	With aluminum rod, length 200 mm								
	Snap-action contacts	1 NO + 1 NC --		▶	3SE5 112-0CH80		1	1 unit	41K
	With plastic rod, length 200 mm								
	Snap-action contacts	1 NO + 1 NC --		B	3SE5 112-0CH82		1	1 unit	41K



Twist lever



Twist lever, adjustable length, with grid hole



Twist lever, adjustable length



Fork lever



Rod actuator

For online configurator see www.siemens.com/sirius/configurators.

⊕ Positive opening according to IEC 60947-5-1, Appendix K.

¹⁾ Popular versions.

Note:









If the device you require is not available as a complete unit, see "Modular System", page 12/36.

SIRIUS 3SE5 Mechanical Position Switches

3SE5, metal enclosures Enclosure width 40 mm acc. to EN 50041

Modular system

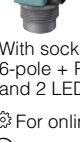
2 or 3 contacts · Degree of protection IP66/IP67 · Cable entry M20 × 1.5

Version	Contacts	LEDs	DT	Modular system	PU (UNIT, SET, M)	PS*	PG
				Configurator			
				Order No.	Price per PU		
Basic switches · Enclosure width 40 mm							
	With M20 × 1.5 connecting thread						
	Slow-action contacts	1 NO + 1 NC --	⊕ B	3SE5 112-0BA00	1	1 unit	41K
	Snap-action contacts	1 NO + 1 NC --	⊕ A	3SE5 112-0CA00	1	1 unit	41K
	• Gold-plated contacts		⊕ B	3SE5 112-0CA00-1AC1	1	1 unit	41K
	Slow-action contacts	1 NO + 2 NC --	⊕ A	3SE5 112-0KA00	1	1 unit	41K
	Snap-action contacts	1 NO + 2 NC --	⊕ A	3SE5 112-0LA00	1	1 unit	41K
	Slow-action contacts with make-before-break	1 NO + 2 NC --	⊕ A	3SE5 112-0MA00	1	1 unit	41K
	Slow-action contacts	2 NO + 1 NC --	⊕ A	3SE5 112-0PA00	1	1 unit	41K
	With increased corrosion protection¹⁾						
	Slow-action contacts	1 NO + 1 NC --	⊕ B	3SE5 112-0BA00-1CA0	1	1 unit	41K
	Snap-action contacts	1 NO + 1 NC --	⊕ B	3SE5 112-0CA00-1CA0	1	1 unit	41K
	Slow-action contacts	1 NO + 2 NC --	⊕ B	3SE5 112-0KA00-1CA0	1	1 unit	41K
	Snap-action contacts	1 NO + 2 NC --	⊕ B	3SE5 112-0LA00-1CA0	1	1 unit	41K
	Slow-action contacts with make-before-break	1 NO + 2 NC --	⊕ B	3SE5 112-0MA00-1CA0	1	1 unit	41K
	Slow-action contacts	2 NO + 1 NC --	⊕ B	3SE5 112-0PA00-1CA0	1	1 unit	41K
	With M12 connector socket, 5-pole (125 V, 4 A)						
	Slow-action contacts	1 NO + 1 NC --	⊕ B	3SE5 114-0BA00-1AC5	1	1 unit	41K
	Snap-action contacts	1 NO + 1 NC --	⊕ B	3SE5 114-0CA00-1AC5	1	1 unit	41K
	Slow-action contacts	2 NC --	⊕ B	3SE5 114-0KA00-1AE1	1	1 unit	41K
	Snap-action contacts	2 NC --	⊕ B	3SE5 114-0LA00-1AE1	1	1 unit	41K
	With connector socket, 6-pole + PE (250 V, 10 A)						
	Slow-action contacts	1 NO + 2 NC --	⊕ B	3SE5 115-0KA00-1AD1	1	1 unit	41K
	Snap-action contacts	1 NO + 2 NC --	⊕ B	3SE5 115-0LA00-1AD1	1	1 unit	41K
	With connector socket, 6-pole + PE (250 V, 10 A) and quick-release device						
	Snap-action contacts	1 NO + 1 NC --	⊕ B	3SE5 115-0CA00-1AD0	1	1 unit	41K
	With 2 LEDs, yellow/green						
	Slow-action contacts	1 NO + 2 NC 24 V DC	⊕ B	3SE5 112-1KA00	1	1 unit	41K
	Snap-action contacts	1 NO + 2 NC 24 V DC	⊕ B	3SE5 112-1LA00	1	1 unit	41K
	Slow-action contacts	1 NO + 2 NC 230 V AC	⊕ B	3SE5 112-3KA00	1	1 unit	41K
	Snap-action contacts	1 NO + 2 NC 230 V AC	⊕ B	3SE5 112-3LA00	1	1 unit	41K
	With M12 connector socket, 5-pole (125 V, 4 A) and 2 LEDs						
	Slow-action contacts	1 NO + 1 NC 24 V DC	⊕ B	3SE5 114-1BA00-1AF3	1	1 unit	41K
	Snap-action contacts	1 NO + 1 NC 24 V DC	⊕ B	3SE5 114-1CA00-1AF3	1	1 unit	41K
	With M12 connector socket, 8-pole (30 V, 2 A) and 2 LEDs						
	Snap-action contacts	1 NO + 2 NC 24 V DC	⊕ B	3SE5 114-1LA00-1AD4	1	1 unit	41K
	With connector socket, 6-pole + PE (10 A), and 2 LEDs						
	Slow-action contacts	1 NO + 1 NC 24 V DC	⊕ B	3SE5 115-1BA00-1AF2	1	1 unit	41K
	Snap-action contacts	1 NO + 1 NC 24 V DC	⊕ B	3SE5 115-1CA00-1AF2	1	1 unit	41K
	Snap-action contacts	2 NC 24 V DC	⊕ B	3SE5 115-1LA00-1AD2	1	1 unit	41K

For online configurator see www.siemens.com/sirius/configurators.

⊕ Positive opening according to IEC 60947-5-1, Appendix K, or positively driven actuator, necessary in safety circuits.







¹⁾ Use corresponding high-grade steel lever.

Note:

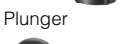
Selection aid see page 12/12.

SIRIUS 3SE5 Mechanical Position Switches

3SE5, metal enclosures
Enclosure width 40 mm acc. to EN 50041

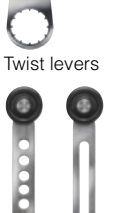
Version	Diameter	DT	Modular system	PU (UNIT, SET, M)	PS*	PG	
	mm		Order No.	Price per PU			
Operating mechanisms							
	Plain plungers						
	High-grade steel plungers	10	⊕ A	3SE5 000-0AB01	1	1 unit	41K
	Rounded plungers, type B acc. to EN 50041						
	High-grade steel plungers, with 3 mm overtravel	10	⊕ B	3SE5 000-0AC02	1	1 unit	41K
	Roller plungers, type C acc. to EN 50041						
	High-grade steel roller, with 3 mm overtravel	13	⊕ B	3SE5 000-0AD02	1	1 unit	41K
	Roller levers						
	Metal lever, plastic roller	22	⊕ A	3SE5 000-0AE01	1	1 unit	41K
	Metal lever, high-grade steel roller	22	⊕ B	3SE5 000-0AE02	1	1 unit	41K
	High-grade steel lever, plastic roller	22	⊕ B	3SE5 000-0AE03	1	1 unit	41K
	Angular roller levers						
	Metal lever, plastic roller	22	⊕ A	3SE5 000-0AF01	1	1 unit	41K
	Metal lever, high-grade steel roller	22	⊕ B	3SE5 000-0AF02	1	1 unit	41K
	High-grade steel lever, plastic roller	22	⊕ B	3SE5 000-0AF03	1	1 unit	41K
	Spring rods (for switches with snap-action contacts only)						
	Plastic plunger and high-grade steel spring:	7					
	• Length 142.5 mm (spring 50 mm, plunger 50 mm)		B	3SE5 000-0AR01	1	1 unit	41K
	• Length 76 mm (spring 23.5 mm, plunger 10 mm)		B	3SE5 000-0AR03	1	1 unit	41K
• Length 242.5 mm (spring 150 mm, plunger 50 mm)		B	3SE5 000-0AR04	1	1 unit	41K	
High-grade steel plunger and spring:	7						
• Length 142.5 mm (spring 50 mm, plunger 50 mm)		B	3SE5 000-0AR02	1	1 unit	41K	
Twist actuators							
	Twist actuators, metal (without lever)						
	• For twist levers and rod actuators, switching right and/or left, adjustable		⊕ A	3SE5 000-0AH00	1	1 unit	41K
	Levers for twist actuators						
	• For fork levers, latching		⊕ B	3SE5 000-0AT10	1	1 unit	41K
	Twist levers, offset, type A acc. to EN 50041						
	Metal lever 27 mm, plastic roller	19	⊕ A	3SE5 000-0AA01	1	1 unit	41K
	Metal lever 27 mm, high-grade steel roller	19	⊕ A	3SE5 000-0AA02	1	1 unit	41K
	Metal lever 27 mm, roller with ball bearing	19	⊕ B	3SE5 000-0AA03	1	1 unit	41K
	Metal lever 27 mm, 2 plastic rollers	19	⊕ B	3SE5 000-0AA04	1	1 unit	41K
	Metal lever 27 mm, plastic roller	30	⊕ B	3SE5 000-0AA05	1	1 unit	41K
	Metal lever 27 mm, rubber roller	50	⊕ B	3SE5 000-0AA08	1	1 unit	41K
	High-grade steel lever 27 mm, plastic roller	19	⊕ B	3SE5 000-0AA11	1	1 unit	41K
	High-grade steel lever 27 mm, high-grade steel roller	19	⊕ B	3SE5 000-0AA12	1	1 unit	41K
	Metal lever 35 mm, plastic roller	19	⊕ B	3SE5 000-0AA15	1	1 unit	41K
	Twist levers 30 mm, straight¹⁾						
	Metal lever, plastic roller	19	⊕ B	3SE5 000-0AA24	1	1 unit	41K
	Twist levers, adjustable length, with grid hole						
	Metal lever, plastic roller	19	⊕ B	3SE5 000-0AA60	1	1 unit	41K
	Metal lever, high-grade steel roller	19	⊕ B	3SE5 000-0AA61	1	1 unit	41K
Metal lever, rubber roller	50	⊕ B	3SE5 000-0AA68	1	1 unit	41K	
High-grade steel lever, plastic roller	19	⊕ B	3SE5 000-0AA62	1	1 unit	41K	
High-grade steel lever, high-grade steel roller	19	⊕ B	3SE5 000-0AA63	1	1 unit	41K	
Twist levers, adjustable length							
Metal lever, plastic roller	19	A	3SE5 000-0AA50	1	1 unit	41K	
Metal lever, high-grade steel roller	19	B	3SE5 000-0AA51	1	1 unit	41K	
Metal lever, plastic roller	30	B	3SE5 000-0AA55	1	1 unit	41K	
Metal lever, rubber roller	50	B	3SE5 000-0AA58	1	1 unit	41K	
High-grade steel lever, plastic roller	19	B	3SE5 000-0AA52	1	1 unit	41K	
High-grade steel lever, high-grade steel roller	19	B	3SE5 000-0AA53	1	1 unit	41K	
Fork levers (for switches with snap-action contacts only)							
2 metal levers, 2 plastic rollers	19	⊕ B	3SE5 000-0AT01	1	1 unit	41K	
2 metal levers, 2 high-grade steel rollers	19	⊕ B	3SE5 000-0AT02	1	1 unit	41K	
2 high-grade steel levers, 2 plastic rollers	19	⊕ B	3SE5 000-0AT03	1	1 unit	41K	
Rod actuators, type D acc. to EN 50041							
Aluminum rod, length 200 mm	6	B	3SE5 000-0AA80	1	1 unit	41K	
Spring rod, length 200 mm	6	B	3SE5 000-0AA81	1	1 unit	41K	
Plastic rod, length 200 mm	6	B	3SE5 000-0AA82	1	1 unit	41K	

⊕ Positively driven actuator, necessary in safety circuits.

¹⁾ Can be clinch mounted (turned through 180°, rear of lever).

SIRIUS 3SE5 Mechanical Position Switches

3SE5, metal enclosures Enclosure width 56 mm

Selection and ordering data

Complete units

2 or 3 contacts · Degree of protection IP66/IP67 · Cable entry 3 × (M20 × 1.5)

Version	Contacts	LEDs	DT	Complete units	<input type="checkbox"/>	PU (UNIT, SET, M)	PS*	PG
				Configurator				
				Order No.		Price per PU		

Complete units¹⁾ · Enclosure width 56 mm



Plain plunger

Plain plungers

With high-grade steel plunger

Slow-action contacts	1 NO + 1 NC --	⊕ B	3SE5 122-0BB01	1	1 unit	41K
Snap-action contacts	1 NO + 1 NC --	⊕ B	3SE5 122-0CB01	1	1 unit	41K
Slow-action contacts	1 NO + 2 NC --	⊕ B	3SE5 122-0KB01	1	1 unit	41K
Snap-action contacts	1 NO + 2 NC --	⊕ B	3SE5 122-0LB01	1	1 unit	41K
Slow-action contacts	2 NO + 1 NC --	⊕ B	3SE5 122-0PB01	1	1 unit	41K



Rounded plunger

Rounded plungers

With high-grade steel plungers, with 3 mm overtravel

Slow-action contacts	1 NO + 1 NC --	⊕ B	3SE5 122-0BC02	1	1 unit	41K
Snap-action contacts	1 NO + 1 NC --	⊕ ▶	3SE5 122-0CC02	1	1 unit	41K
Slow-action contacts	1 NO + 2 NC --	⊕ B	3SE5 122-0KC02	1	1 unit	41K
Snap-action contacts	1 NO + 2 NC --	⊕ B	3SE5 122-0LC02	1	1 unit	41K
Slow-action contacts	2 NO + 1 NC --	⊕ B	3SE5 122-0PC02	1	1 unit	41K



Roller plunger

Roller plungers

With high-grade steel roller 13 mm, with 3 mm overtravel

Slow-action contacts	1 NO + 1 NC --	⊕ B	3SE5 122-0BD02	1	1 unit	41K
Snap-action contacts	1 NO + 1 NC --	⊕ A	3SE5 122-0CD02	1	1 unit	41K
Slow-action contacts	1 NO + 2 NC --	⊕ B	3SE5 122-0KD02	1	1 unit	41K
Snap-action contacts	1 NO + 2 NC --	⊕ B	3SE5 122-0LD02	1	1 unit	41K



Roller lever

Roller levers

With metal lever and plastic roller 22 mm

Slow-action contacts	1 NO + 1 NC --	⊕ B	3SE5 122-0BE01	1	1 unit	41K
Snap-action contacts	1 NO + 1 NC --	⊕ A	3SE5 122-0CE01	1	1 unit	41K
Slow-action contacts	1 NO + 2 NC --	⊕ B	3SE5 122-0KE01	1	1 unit	41K
Snap-action contacts	1 NO + 2 NC --	⊕ B	3SE5 122-0LE01	1	1 unit	41K
Slow-action contacts	2 NO + 1 NC --	⊕ B	3SE5 122-0PE01	1	1 unit	41K

With metal lever and high-grade steel roller 22 mm

Snap-action contacts	1 NO + 1 NC --	⊕ B	3SE5 122-0CE02	1	1 unit	41K
----------------------	----------------	-----	----------------	---	--------	-----



Angular roller lever

Angular roller levers

With metal lever and plastic roller 22 mm

Slow-action contacts	1 NO + 1 NC --	⊕ B	3SE5 122-0BF01	1	1 unit	41K
Snap-action contacts	1 NO + 1 NC --	⊕ B	3SE5 122-0CF01	1	1 unit	41K
Slow-action contacts	2 NO + 1 NC --	⊕ B	3SE5 122-0PF01	1	1 unit	41K

For online configurator see www.siemens.com/sirius/configurators.

⊕ Positive opening according to IEC 60947-5-1, Appendix K.

¹⁾ Popular versions.

SIRIUS 3SE5 Mechanical Position Switches

3SE5, metal enclosures
Enclosure width 56 mm

2 or 3 contacts · Degree of protection IP66/IP67 · Cable entry 3 × (M20 × 1.5)

Version	Contacts	LEDs	DT	Complete units	<input type="checkbox"/>	PU (UNIT, SET, M)	PS*	PG
				Configurator				
				Order No.		Price per PU		

Complete units¹⁾ · Enclosure width 56 mm



Spring rod

Spring rods

Length 142.5 mm, with plastic plunger 50 mm

Snap-action contacts	1 NO + 1 NC --		B	3SE5 122-0CR01		1	1 unit	41K
----------------------	----------------	--	---	-----------------------	--	---	--------	-----



Twist lever

Twist levers

With metal lever 27 mm and plastic roller 19 mm

Slow-action contacts	1 NO + 1 NC --		B	3SE5 122-0BH01		1	1 unit	41K
----------------------	----------------	--	---	-----------------------	--	---	--------	-----

Snap-action contacts	1 NO + 1 NC --		A	3SE5 122-0CH01		1	1 unit	41K
----------------------	----------------	--	---	-----------------------	--	---	--------	-----

Slow-action contacts	1 NO + 2 NC --		B	3SE5 122-0KH01		1	1 unit	41K
----------------------	----------------	--	---	-----------------------	--	---	--------	-----

Snap-action contacts	1 NO + 2 NC --		B	3SE5 122-0LH01		1	1 unit	41K
----------------------	----------------	--	---	-----------------------	--	---	--------	-----

Slow-action contacts	2 NO + 1 NC --		B	3SE5 122-0PH01		1	1 unit	41K
----------------------	----------------	--	---	-----------------------	--	---	--------	-----

With metal lever 27 mm and high-grade steel roller 19 mm

Snap-action contacts	1 NO + 1 NC --		B	3SE5 122-0CH02		1	1 unit	41K
----------------------	----------------	--	---	-----------------------	--	---	--------	-----

Snap-action contacts	1 NO + 2 NC --		B	3SE5 122-0LH02		1	1 unit	41K
----------------------	----------------	--	---	-----------------------	--	---	--------	-----

Twist levers, adjustable length

With metal lever with grid hole and plastic roller 19 mm

Slow-action contacts	1 NO + 1 NC --		B	3SE5 122-0BH60		1	1 unit	41K
----------------------	----------------	--	---	-----------------------	--	---	--------	-----

Snap-action contacts	1 NO + 1 NC --		B	3SE5 122-0CH60		1	1 unit	41K
----------------------	----------------	--	---	-----------------------	--	---	--------	-----

Snap-action contacts	1 NO + 2 NC --		B	3SE5 122-0LH60		1	1 unit	41K
----------------------	----------------	--	---	-----------------------	--	---	--------	-----

With metal lever and plastic roller 19 mm

Slow-action contacts	1 NO + 1 NC --		B	3SE5 122-0BH50		1	1 unit	41K
----------------------	----------------	--	---	-----------------------	--	---	--------	-----

Snap-action contacts	1 NO + 1 NC --		A	3SE5 122-0CH50		1	1 unit	41K
----------------------	----------------	--	---	-----------------------	--	---	--------	-----

Snap-action contacts	1 NO + 2 NC --		B	3SE5 122-0LH50		1	1 unit	41K
----------------------	----------------	--	---	-----------------------	--	---	--------	-----



Twist lever,
adjustable
length

Fork levers, latching

With metal lever and 2 plastic rollers 19 mm

Snap-action contacts	1 NO + 1 NC --		B	3SE5 122-0CT11		1	1 unit	41K
----------------------	----------------	--	---	-----------------------	--	---	--------	-----



Fork lever

Rod actuators

With aluminum rod, length 200 mm

Snap-action contacts	1 NO + 1 NC --		B	3SE5 122-0CH80		1	1 unit	41K
----------------------	----------------	--	---	-----------------------	--	---	--------	-----

With plastic rod, length 200 mm

Snap-action contacts	1 NO + 1 NC --		B	3SE5 122-0CH82		1	1 unit	41K
----------------------	----------------	--	---	-----------------------	--	---	--------	-----



Rod actuator

For online configurator see www.siemens.com/sirius/configurators.

Positive opening according to IEC 60947-5-1, Appendix K.

¹⁾ Popular versions.

Note:

If the device you require is not available as a complete unit, see "Modular System", page 12/40.

SIRIUS 3SE5 Mechanical Position Switches



3SE5, metal enclosures Enclosure width 56 mm

Modular system

2 or 3 contacts · Degree of protection IP66/IP67 · Cable entry 3 × (M20 × 1.5)

Version	Contacts	LEDs	DT	Modular system	PU (UNIT, SET, M)	PS*	PG
				Configurator			
				Order No.	Price per PU		

Basic switches · Enclosure width 56 mm

With 3 x M20 x 1.5 connecting thread								
	Slow-action contacts	1 NO + 1 NC	--	⊕ A	3SE5 122-0BA00	1	1 unit	41K
	Snap-action contacts	1 NO + 1 NC	--	⊕ A	3SE5 122-0CA00	1	1 unit	41K
	Slow-action contacts	1 NO + 2 NC	--	⊕ B	3SE5 122-0KA00	1	1 unit	41K
	Snap-action contacts	1 NO + 2 NC	--	⊕ A	3SE5 122-0LA00	1	1 unit	41K
	Slow-action contacts with make-before-break	1 NO + 2 NC	--	⊕ A	3SE5 122-0MA00	1	1 unit	41K
	Slow-action contacts	2 NO + 1 NC	--	⊕ A	3SE5 122-0PA00	1	1 unit	41K
With increased corrosion protection ¹⁾								
	Slow-action contacts	1 NO + 1 NC	--	⊕ B	3SE5 122-0BA00-1CA0	1	1 unit	41K
	Snap-action contacts	1 NO + 1 NC	--	⊕ B	3SE5 122-0CA00-1CA0	1	1 unit	41K
	Slow-action contacts	1 NO + 2 NC	--	⊕ B	3SE5 122-0KA00-1CA0	1	1 unit	41K
	Snap-action contacts	1 NO + 2 NC	--	⊕ B	3SE5 122-0LA00-1CA0	1	1 unit	41K
	Slow-action contacts with make-before-break	1 NO + 2 NC	--	⊕ B	3SE5 122-0MA00-1CA0	1	1 unit	41K
	Slow-action contacts	2 NO + 1 NC	--	⊕ B	3SE5 122-0PA00-1CA0	1	1 unit	41K
With 2 LEDs, yellow/green								
	Slow-action contacts	1 NO + 2 NC	24 V DC	⊕ B	3SE5 122-1KA00	1	1 unit	41K
	Snap-action contacts	1 NO + 2 NC	24 V DC	⊕ B	3SE5 122-1LA00	1	1 unit	41K
	Slow-action contacts	1 NO + 2 NC	230 V AC	⊕ B	3SE5 122-3KA00	1	1 unit	41K
	Snap-action contacts	1 NO + 2 NC	230 V AC	⊕ B	3SE5 122-3LA00	1	1 unit	41K

⊕ For online configurator see www.siemens.com/sirius/configurators.

⊕ Positive opening according to IEC 60947-5-1, Appendix K, or positively driven actuator, necessary in safety circuits.





¹⁾ Use corresponding high-grade steel lever.

Note:

Selection aid see page 12/12.

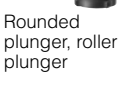



Version	Diameter	DT	Modular system	PU (UNIT, SET, M)	PS*	PG
	mm		Order No.	Price per PU		

Operating mechanisms

	Plain plungers High-grade steel plungers	10	⊕ A	3SE5 000-0AB01	1	1 unit	41K
	Rounded plungers, type B acc. to EN 50041 High-grade steel plungers, with 3 mm overtravel	10	⊕ B	3SE5 000-0AC02	1	1 unit	41K
	Roller plungers, type C acc. to EN 50041 High-grade steel roller, with 3 mm overtravel	13	⊕ B	3SE5 000-0AD02	1	1 unit	41K
	Roller levers Metal lever, plastic roller	22	⊕ A	3SE5 000-0AE01	1	1 unit	41K
	Metal lever, high-grade steel roller	22	⊕ B	3SE5 000-0AE02	1	1 unit	41K
	High-grade steel lever, plastic roller	22	⊕ B	3SE5 000-0AE03	1	1 unit	41K
	High-grade steel lever, high-grade steel roller	22	⊕ B	3SE5 000-0AE04	1	1 unit	41K
	Angular roller levers Metal lever, plastic roller	22	⊕ A	3SE5 000-0AF01	1	1 unit	41K
	Metal lever, high-grade steel roller	22	⊕ B	3SE5 000-0AF02	1	1 unit	41K
	High-grade steel lever, plastic roller	22	⊕ B	3SE5 000-0AF03	1	1 unit	41K
	High-grade steel lever, high-grade steel roller	22	⊕ B	3SE5 000-0AF04	1	1 unit	41K
	Spring rods (for switches with snap-action contacts only) Plastic plunger and high-grade steel spring:	7					
	• Length 142.5 mm (spring 50 mm, plunger 50 mm)		B	3SE5 000-0AR01	1	1 unit	41K
	• Length 76 mm (spring 23.5 mm, plunger 10 mm)		B	3SE5 000-0AR03	1	1 unit	41K
	• Length 242.5 mm (spring 150 mm, plunger 50 mm)		B	3SE5 000-0AR04	1	1 unit	41K
	High-grade steel plunger and spring:	7					
	• Length 142.5 mm (spring 50 mm, plunger 50 mm)		B	3SE5 000-0AR02	1	1 unit	41K

SIRIUS 3SE5 Mechanical Position Switches

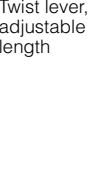
3SE5, metal enclosures
Enclosure width 56 mm

Version	Diameter	DT	Modular system	PU (UNIT, SET, M)	PS*	PG	
	mm		Order No.	Price per PU			
Twist actuators							
	Twist actuators , metal (without lever)						
	<ul style="list-style-type: none"> For twist levers and rod actuators, switching right and/or left, adjustable For fork levers, latching 						
		⊕ A	3SE5 000-0AH00	1	1 unit	41K	
		⊕ B	3SE5 000-0AT10	1	1 unit	41K	
Levers for twist actuators							
	Twist levers 27 mm, offset, type A acc. to EN 50041						
	Metal lever, plastic roller	19	⊕ A	3SE5 000-0AA01	1	1 unit	41K
	Metal lever, high-grade steel roller	19	⊕ A	3SE5 000-0AA02	1	1 unit	41K
	Metal lever, roller with ball bearing	19	⊕ B	3SE5 000-0AA03	1	1 unit	41K
	Metal lever, 2 plastic rollers	19	⊕ B	3SE5 000-0AA04	1	1 unit	41K
	Metal lever, plastic roller	30	⊕ B	3SE5 000-0AA05	1	1 unit	41K
	Metal lever, plastic roller	50	⊕ B	3SE5 000-0AA07	1	1 unit	41K
	Metal lever, rubber roller	50	⊕ B	3SE5 000-0AA08	1	1 unit	41K
	High-grade steel lever, plastic roller	19	⊕ B	3SE5 000-0AA11	1	1 unit	41K
	High-grade steel lever, high-grade steel roller	19	⊕ B	3SE5 000-0AA12	1	1 unit	41K
	Twist levers 35 mm, offset						
	Metal lever, plastic roller	19	⊕ B	3SE5 000-0AA15	1	1 unit	41K
Twist levers 30 mm, straight¹⁾							
Metal lever, plastic roller	19	⊕ B	3SE5 000-0AA24	1	1 unit	41K	
Metal lever, plastic roller	30	⊕ B	3SE5 000-0AA26	1	1 unit	41K	
	Twist levers, adjustable length, with grid hole						
	Metal lever, plastic roller	19	⊕ B	3SE5 000-0AA60	1	1 unit	41K
	Metal lever, high-grade steel roller	19	⊕ B	3SE5 000-0AA61	1	1 unit	41K
	Metal lever, plastic roller	50	⊕ B	3SE5 000-0AA67	1	1 unit	41K
	Metal lever, rubber roller	50	⊕ B	3SE5 000-0AA68	1	1 unit	41K
	High-grade steel lever, plastic roller	19	⊕ B	3SE5 000-0AA62	1	1 unit	41K
	High-grade steel lever, high-grade steel roller	19	⊕ B	3SE5 000-0AA63	1	1 unit	41K
	Twist levers, adjustable length						
	Metal lever, plastic roller	19	A	3SE5 000-0AA50	1	1 unit	41K
	Metal lever, high-grade steel roller	19	B	3SE5 000-0AA51	1	1 unit	41K
	Metal lever, plastic roller	30	B	3SE5 000-0AA55	1	1 unit	41K
	Metal lever, plastic roller	50	B	3SE5 000-0AA57	1	1 unit	41K
	Metal lever, rubber roller	50	B	3SE5 000-0AA58	1	1 unit	41K
	High-grade steel lever, plastic roller	19	B	3SE5 000-0AA52	1	1 unit	41K
High-grade steel lever, high-grade steel roller	19	B	3SE5 000-0AA53	1	1 unit	41K	
	Fork levers (for switches with snap-action contacts only)						
	2 metal levers, 2 plastic rollers	19	⊕ B	3SE5 000-0AT01	1	1 unit	41K
	2 metal levers, 2 high-grade steel rollers	19	⊕ B	3SE5 000-0AT02	1	1 unit	41K
	2 high-grade steel levers, 2 plastic rollers	19	⊕ B	3SE5 000-0AT03	1	1 unit	41K
	2 high-grade steel levers, 2 high-grade steel rollers	19	⊕ B	3SE5 000-0AT04	1	1 unit	41K
	Rod actuators, type D acc. to EN 50041						
	Aluminum rod, length 200 mm	6	B	3SE5 000-0AA80	1	1 unit	41K
	Spring rod, length 200 mm	6	B	3SE5 000-0AA81	1	1 unit	41K
	Plastic rod, length 200 mm	6	B	3SE5 000-0AA82	1	1 unit	41K

⊕ Positively driven actuator, necessary in safety circuits.

¹⁾ Can be clinch mounted (turned through 180°, rear of lever).

SIRIUS 3SE5 Mechanical Position Switches

Metal enclosures Enclosure width 56 mm, XL

Selection and ordering data

Complete units

4 or 5 contacts · Degree of protection IP66/IP67 · Cable entry 3 × (M20 × 1.5)

Version	Contacts	LEDs	DT	Complete units	<input type="checkbox"/>	PU (UNIT, SET, M)	PS*	PG
				Configurator				
				Order No.		Price per PU		

Complete units¹⁾ · Enclosure width 56 mm, XL



Plain plunger

Plain plungers

With high-grade steel plunger

Snap-action contacts 2 × (1 NO + 1 NC) -- B **3SE5 162-0CB01** 1 1 unit 41K



Rounded plunger

Rounded plungers

With high-grade steel plungers, with 3 mm overtravel

Slow-action contacts 1 NO + 1 NC and -- B **3SE5 162-0EC02** 1 1 unit 41K
 Slow-action contacts with make-before-break 1 NO + 2 NC
 2 mm travel difference



Roller plunger

Roller plungers

With high-grade steel roller 13 mm, with 3 mm overtravel

Slow-action contacts 2 × (1 NO + 1 NC) -- B **3SE5 162-0BD02** 1 1 unit 41K
 Snap-action contacts 2 × (1 NO + 1 NC) -- A **3SE5 162-0CD02** 1 1 unit 41K



Roller lever

Roller levers

With metal lever and plastic roller 22 mm

Slow-action contacts 2 × (1 NO + 1 NC) -- B **3SE5 162-0BE01** 1 1 unit 41K
 Snap-action contacts 2 × (1 NO + 1 NC) -- A **3SE5 162-0CE01** 1 1 unit 41K

With metal lever and high-grade steel roller 22 mm

Snap-action contacts 2 × (1 NO + 1 NC) -- B **3SE5 162-0CE02** 1 1 unit 41K



Angular roller lever

Angular roller levers

With metal lever and plastic roller 22 mm

Snap-action contacts 2 × (1 NO + 1 NC) -- B **3SE5 162-0CF01** 1 1 unit 41K



Twist lever

Twist levers

With metal lever 27 mm and plastic roller 19 mm

Snap-action contacts 2 × (1 NO + 1 NC) -- A **3SE5 162-0CH01** 1 1 unit 41K

For online configurator see www.siemens.com/sirius/configurators.

Positive opening according to IEC 60947-5-1, Appendix K.

¹⁾ Popular versions.

Note:



If the device you require is not available as a complete unit, see "Modular System", page 12/43.

SIRIUS 3SE5 Mechanical Position Switches

Metal enclosures
Enclosure width 56 mm, XL

Modular system

4 or 6 contacts · Degree of protection IP66/IP67 · Cable entry 3 × (M20 × 1.5)

Version	Contacts	LEDs	DT	Modular system	PU (UNIT, SET, M)	PS*	PG
							
							
				Order No.	Price per PU		

Basic switches • Enclosure width 56 mm, XL



Basic switch

With 3 x M20 x 1.5 connecting thread

Slow-action contacts	2 × (1 NO + 1 NC) --	⊕ A	3SE5 162-0BA00	1	1 unit	41K
Snap-action contacts	2 × (1 NO + 1 NC) --	⊕ A	3SE5 162-0CA00	1	1 unit	41K
Slow-action contacts with make-before-break	2 × (1 NO + 2 NC) --	⊕ A	3SE5 162-0DA00	1	1 unit	41K

With increased corrosion protection¹⁾

Slow-action contacts	2 × (1 NO + 1 NC) --	⊕ B	3SE5 162-0BA00-1CA0	1	1 unit	41K
Snap-action contacts	2 × (1 NO + 1 NC) --	⊕ B	3SE5 162-0CA00-1CA0	1	1 unit	41K
Slow-action contacts with make-before-break	2 × (1 NO + 2 NC) --	⊕ B	3SE5 162-0DA00-1CA0	1	1 unit	41K

 For online configurator see www.siemens.com/sirius/configurators.

⊕ Positively opening according to IEC 60947-5-1, Appendix K, or positively driven actuator, necessary in safety circuits.

¹⁾ Use corresponding high-grade steel lever.

Note:

Selection aid see page 12/12.

Version	Diameter	DT	Modular system	PU (UNIT, SET, M)	PS*	PG
	mm					
			Order No.	Price per PU		

Operating mechanisms



Plain plunger

Plain plungers

High-grade steel plungers	10	⊕ A	3SE5 000-0AB01	1	1 unit	41K
---------------------------	----	-----	-----------------------	---	--------	-----



Rounded plunger

Rounded plungers, type B acc. to EN 50041

High-grade steel plungers, with 3 mm overtravel	10	⊕ B	3SE5 000-0AC02	1	1 unit	41K
---	----	-----	-----------------------	---	--------	-----



Roller plunger

Roller plungers, type C acc. to EN 50041

High-grade steel roller, with 3 mm overtravel	13	⊕ B	3SE5 000-0AD02	1	1 unit	41K
---	----	-----	-----------------------	---	--------	-----



Roller lever

Roller levers

Metal lever, plastic roller	22	⊕ A	3SE5 000-0AE01	1	1 unit	41K
Metal lever, high-grade steel roller	22	⊕ B	3SE5 000-0AE02	1	1 unit	41K
High-grade steel lever, plastic roller	22	⊕ B	3SE5 000-0AE03	1	1 unit	41K
High-grade steel lever, high-grade steel roller	22	⊕ B	3SE5 000-0AE04	1	1 unit	41K



Angular roller lever

Angular roller levers

Metal lever, plastic roller	22	⊕ A	3SE5 000-0AF01	1	1 unit	41K
Metal lever, high-grade steel roller	22	⊕ B	3SE5 000-0AF02	1	1 unit	41K
High-grade steel lever, plastic roller	22	⊕ B	3SE5 000-0AF03	1	1 unit	41K
High-grade steel lever, high-grade steel roller	22	⊕ B	3SE5 000-0AF04	1	1 unit	41K



Spring rod







Spring rods (for switches with snap-action contacts only)

Plastic plunger and high-grade steel spring:	7					
• Length 142.5 mm (spring 50 mm, plunger 50 mm)		B	3SE5 000-0AR01	1	1 unit	41K
• Length 76 mm (spring 23.5 mm, plunger 10 mm)		B	3SE5 000-0AR03	1	1 unit	41K
• Length 242.5 mm (spring 150 mm, plunger 50 mm)		B	3SE5 000-0AR04	1	1 unit	41K
High-grade steel plunger and spring:	7					
• Length 142.5 mm (spring 50 mm, plunger 50 mm)		B	3SE5 000-0AR02	1	1 unit	41K

⊕ Positively driven actuator, necessary in safety circuits.

SIRIUS 3SE5 Mechanical Position Switches

Metal enclosures Enclosure width 56 mm, XL

Version	Diameter	DT	Modular system	PU (UNIT, SET, M)	PS*	PG	
	mm		Order No.	Price per PU			
Twist actuators							
	Twist actuators , metal (without lever)						
	<ul style="list-style-type: none"> For twist levers and rod actuators, switching right and/or left, adjustable For fork levers, latching 						
		⊕ A	3SE5 000-0AH00	1	1 unit	41K	
		⊕ B	3SE5 000-0AT10	1	1 unit	41K	
Levers for twist actuators							
	Twist levers 27 mm, offset, type A acc. to EN 50041						
	Metal lever, plastic roller	19	⊕ A	3SE5 000-0AA01	1	1 unit	41K
	Metal lever, high-grade steel roller	19	⊕ A	3SE5 000-0AA02	1	1 unit	41K
	Metal lever, roller with ball bearing	19	⊕ B	3SE5 000-0AA03	1	1 unit	41K
	Metal lever, 2 plastic rollers	19	⊕ B	3SE5 000-0AA04	1	1 unit	41K
	Metal lever, plastic roller	30	⊕ B	3SE5 000-0AA05	1	1 unit	41K
	Metal lever, plastic roller	50	⊕ B	3SE5 000-0AA07	1	1 unit	41K
	Metal lever, rubber roller	50	⊕ B	3SE5 000-0AA08	1	1 unit	41K
	High-grade steel lever, plastic roller	19	⊕ B	3SE5 000-0AA11	1	1 unit	41K
	High-grade steel lever, high-grade steel roller	19	⊕ B	3SE5 000-0AA12	1	1 unit	41K
	Twist levers 35 mm, offset						
	Metal lever, plastic roller	19	⊕ B	3SE5 000-0AA15	1	1 unit	41K
Twist levers 30 mm, straight¹⁾							
Metal lever, plastic roller	19	⊕ B	3SE5 000-0AA24	1	1 unit	41K	
Metal lever, plastic roller	30	⊕ B	3SE5 000-0AA26	1	1 unit	41K	
	Twist levers, adjustable length, with grid hole						
	Metal lever, plastic roller	19	⊕ B	3SE5 000-0AA60	1	1 unit	41K
	Metal lever, high-grade steel roller	19	⊕ B	3SE5 000-0AA61	1	1 unit	41K
	Metal lever, plastic roller	50	⊕ B	3SE5 000-0AA67	1	1 unit	41K
	Metal lever, rubber roller	50	⊕ B	3SE5 000-0AA68	1	1 unit	41K
	High-grade steel lever, plastic roller	19	⊕ B	3SE5 000-0AA62	1	1 unit	41K
	High-grade steel lever, high-grade steel roller	19	⊕ B	3SE5 000-0AA63	1	1 unit	41K
	Twist levers, adjustable length						
	Metal lever, plastic roller	19	A	3SE5 000-0AA50	1	1 unit	41K
	Metal lever, high-grade steel roller	19	B	3SE5 000-0AA51	1	1 unit	41K
	Metal lever, plastic roller	30	B	3SE5 000-0AA55	1	1 unit	41K
	Metal lever, plastic roller	50	B	3SE5 000-0AA57	1	1 unit	41K
	Metal lever, rubber roller	50	B	3SE5 000-0AA58	1	1 unit	41K
	High-grade steel lever, plastic roller	19	B	3SE5 000-0AA52	1	1 unit	41K
High-grade steel lever, high-grade steel roller	19	B	3SE5 000-0AA53	1	1 unit	41K	
	Fork levers (for switches with snap-action contacts only)						
	2 metal levers, 2 plastic rollers	19	⊕ B	3SE5 000-0AT01	1	1 unit	41K
	2 metal levers, 2 high-grade steel rollers	19	⊕ B	3SE5 000-0AT02	1	1 unit	41K
	2 high-grade steel levers, 2 plastic rollers	19	⊕ B	3SE5 000-0AT03	1	1 unit	41K
	2 high-grade steel levers, 2 high-grade steel rollers	19	⊕ B	3SE5 000-0AT04	1	1 unit	41K
	Rod actuators, type D acc. to EN 50041						
	Aluminum rod, length 200 mm	6	B	3SE5 000-0AA80	1	1 unit	41K
	Spring rod, length 200 mm	6	B	3SE5 000-0AA81	1	1 unit	41K
	Plastic rod, length 200 mm	6	B	3SE5 000-0AA82	1	1 unit	41K
	Plastic rod, length 330 mm	6	B	3SE5 000-0AA83	1	1 unit	41K

⊕ Positively driven actuator, necessary in safety circuits.

¹⁾ Can be clinch mounted (turned through 180°, rear of lever).

3SE5, metal enclosures
Ambient temperature to -40 °C

Selection and ordering data

Modular system

2 or 3 contacts · Degree of protection IP66/IP67 · Cable entry M20 × 1.5

Version	Contacts	LEDs	DT	Modular system	PU (UNIT, SET, M)	PS*	PG
				Order No.	Price per PU		

Basic switches · Enclosure width 31 mm (with rounded plunger¹⁾)



Basic switch

With plunger

Snap-action contacts	1 NO + 1 NC --		B	3SE5 212-0CC05-1AJ0	1	1 unit	41K
Slow-action contacts	1 NO + 2 NC --		B	3SE5 212-0KC05-1AJ0	1	1 unit	41K
Snap-action contacts	1 NO + 2 NC --		B	3SE5 212-0LC05-1AJ0	1	1 unit	41K

For online configurator see www.siemens.com/sirius/configurators.

Positive opening according to IEC 60947-5-1, Appendix K, or positively driven actuator, necessary in safety circuits.

¹⁾ For enclosures with widths of 31 mm, the basic switch is a complete unit with rounded plungers.

Note:

Selection aid see page 12/12.

Version	Diameter	DT	Modular system	PU (UNIT, SET, M)	PS*	PG
	mm					
			Order No.	Price per PU		

Operating mechanisms



Roller plunger

Roller plungers, type C acc. to EN 50047

Plastic rollers	10		B	3SE5 000-0AD03-1AJ0	1	1 unit	41K
-----------------	----	--	---	----------------------------	---	--------	-----



Roller lever

Roller levers, type E acc. to EN 50047

Metal lever, plastic roller	13		B	3SE5 000-0AE10-1AJ0	1	1 unit	41K
High-grade steel lever, plastic roller	13		B	3SE5 000-0AE12-1AJ0	1	1 unit	41K



Angular roller lever

Angular roller levers

Metal lever, plastic roller	13		B	3SE5 000-0AF10-1AJ0	1	1 unit	41K
High-grade steel lever, plastic roller	13		B	3SE5 000-0AF12-1AJ0	1	1 unit	41K

Twist actuators



Twist actuator

Twist actuators, plastic (without lever)

Switching right and/or left, adjustable			B	3SE5 000-0AK00-1AJ0	1	1 unit	41K
---	--	--	---	----------------------------	---	--------	-----

Levers for twist actuators

Twist lever straight, 21 mm, type A acc. to EN 50047

Metal lever, plastic roller	19		B	3SE5 000-0AA21-1AJ0	1	1 unit	41K
High-grade steel lever, plastic roller	19		B	3SE5 000-0AA31-1AJ0	1	1 unit	41K



Twist lever

Twist levers, adjustable length, with grid hole

Metal lever, plastic roller	19		B	3SE5 000-0AA60-1AJ0	1	1 unit	41K
High-grade steel lever, plastic roller	19		B	3SE5 000-0AA62-1AJ0	1	1 unit	41K



Twist lever, adjustable length

Positively driven actuator, necessary in safety circuits.

SIRIUS 3SE5 Mechanical Position Switches

3SE5, metal enclosures Ambient temperature to -40 °C

Complete units

2 or 3 contacts · Degree of protection IP66/IP67 · Cable entry M20 × 1.5

Version	Contacts	LEDs	DT	Complete units	PU (UNIT, SET, M)	PS*	PG
				Configurator			
				Order No.	Price per PU		

Complete units • Enclosure width 40 mm



Rounded plunger

Rounded plungers, type B acc. to EN 50041
With high-grade steel plungers, with 3 mm overtravel
 Snap-action contacts 1 NO + 1 NC --

⊕ B

3SE5 112-0CC02-1AJ0

1

1 unit

41K



Twist lever, adjustable length

Twist levers, adjustable length
With high-grade steel lever with grid hole and plastic roller 19 mm
 Snap-action contacts 1 NO + 1 NC --

⊕ B

3SE5 112-0CH62-1AJ0

1

1 unit

41K

For online configurator see www.siemens.com/sirius/configurators.

Positive opening according to IEC 60947-5-1, Appendix K or positively driven actuator, necessary in safety circuits.

Note:

If the device you require is not available as a complete unit, see "Modular System".

Modular system

2, 3 or 4 contacts · Degree of protection IP66/IP67 · Cable entry M20 × 1.5

Version	Contacts	LEDs	DT	Modular system	PU (UNIT, SET, M)	PS*	PG
				Configurator			
				Order No.	Price per PU		

Basic switches • Enclosure width 40 mm



Basic switch

With M20 × 1.5 connecting thread
 Snap-action contacts 1 NO + 1 NC --
 Slow-action contacts 1 NO + 2 NC --
 Snap-action contacts 1 NO + 2 NC --

⊕ B

3SE5 112-0CA00-1AJ0

1

1 unit

41K

⊕ B

3SE5 112-0KA00-1AJ0

1

1 unit

41K

⊕ B

3SE5 112-0LA00-1AJ0

1

1 unit

41K

Basic switches • Enclosure width 56 mm



Basic switch

With 3 x M20 × 1.5 connecting thread
 Snap-action contacts 1 NO + 1 NC --
 Slow-action contacts 1 NO + 2 NC --
 Snap-action contacts 1 NO + 2 NC --

⊕ B

3SE5 122-0CA00-1AJ0

1

1 unit

41K

⊕ B

3SE5 122-0KA00-1AJ0

1

1 unit

41K

⊕ B

3SE5 122-0LA00-1AJ0

1

1 unit

41K

Basic switches • Enclosure width 56 mm, XL



Basic switch

With 3 x M20 × 1.5 connecting thread
 Slow-action contacts 2 × (1 NO + 1 NC) --
 Snap-action contacts 2 × (1 NO + 1 NC) --

⊕ B

3SE5 162-0BA00-1AJ0

1

1 unit

41K

⊕ B

3SE5 162-0CA00-1AJ0

1

1 unit

41K

For online configurator see www.siemens.com/sirius/configurators.

Positive opening according to IEC 60947-5-1, Appendix K or positively driven actuator, necessary in safety circuits.

Note:

Selection aid see page 12/12.

SIRIUS 3SE5 Mechanical Position Switches

3SE5, metal enclosures
Ambient temperature to **-40 °C**

Version	Diameter	DT	Modular system	PU (UNIT, SET, M)	PS*	PG
	mm		Order No.	Price per PU		
Operating mechanisms						
	Rounded plungers, type B acc. to EN 50041 High-grade steel plungers, with 3 mm overtravel	10	⊕ B	3SE5 000-0AC02-1AJ0	1	1 unit 41K
Rounded plunger						
	Roller plungers, type C acc. to EN 50041 High-grade steel roller, with 3 mm overtravel	10	⊕ B	3SE5 000-0AD02-1AJ0	1	1 unit 41K
Roller plunger						
	Roller levers Metal lever, plastic roller	13	⊕ B	3SE5 000-0AE01-1AJ0	1	1 unit 41K
Roller lever	High-grade steel lever, plastic roller	13	⊕ B	3SE5 000-0AE03-1AJ0	1	1 unit 41K
	Angular roller levers Metal lever, plastic roller	13	⊕ B	3SE5 000-0AF01-1AJ0	1	1 unit 41K
Angular roller lever	High-grade steel lever, plastic roller	13	⊕ B	3SE5 000-0AF03-1AJ0	1	1 unit 41K
Twist actuators						
	Twist actuators, metal (without lever) Switching right and/or left, adjustable		⊕ B	3SE5 000-0AH00-1AJ0	1	1 unit 41K
Twist actuator						
Levers for twist actuators						
	Twist levers, type A acc. to EN 50041 Metal lever, plastic roller	19	⊕ B	3SE5 000-0AA01-1AJ0	1	1 unit 41K
Twist lever	High-grade steel lever, plastic roller	19	⊕ B	3SE5 000-0AA11-1AJ0	1	1 unit 41K
	Twist levers, adjustable length, with grid hole Metal lever, plastic roller	19	⊕ B	3SE5 000-0AA60-1AJ0	1	1 unit 41K
Twist lever, adjustable length	High-grade steel lever, plastic roller	19	⊕ B	3SE5 000-0AA62-1AJ0	1	1 unit 41K

⊕ Positively driven actuator, necessary in safety circuits.

SIRIUS 3SE5 Mechanical Position Switches

3SE5, metal enclosures Compact design

Overview

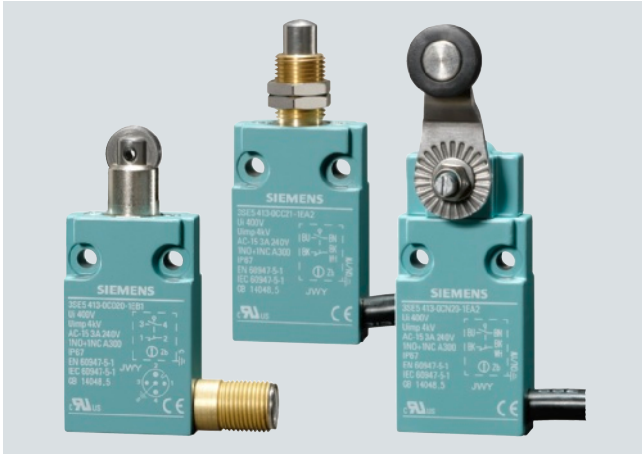

Compact design in width 30 mm

Particularly in harsh environments or on equipment with limited space, the small 3SE5 4 position switches in compact design with a depth of 16 mm and a weight of only 80 g (without cable) are ideal. Above all the versions with molded cable can be mounted in the most confined places.

3SE5 4 compact position switches are available in two different widths as complete units:

- The 3SE5 413 series complies with the EU standard and features a 30 mm wide enclosure with drilled holes at a distance of 20 mm.
- The 3SE5 423 series meets the requirements of the US market and features a 40 mm wide enclosure with drilled holes at a spacing of 25 mm.

Both the enclosure and the twist actuator are made of metal and comply with the high IP67 degree of protection. Following actuators are available:

- Rounded plungers
- Rounded plungers with central fixing
- Rounded plungers with external seal
- Roller plungers
- Roller plunger with central fixing
- Twist levers

The contact block is designed with snap-action contacts 1 NO + 1 NC. The NC contact complies with the requirements for positive opening acc. to IEC 60947-5-1.

Use in safety circuits up to Category 4 according to EN ISO 13849-1.

Connection:







- With molded cable, 2 m or 5 m long
- With M12 connector socket

Benefits

- Very compact yet with the same rating as the 3SE51 standard switches, for notable space savings in confined installation conditions
- Various actuator versions available
- Actuator heads rotatable in increments of 90°
- Time is saved when mounting the fully assembled unit
- With metal enclosure of degree of protection IP67, ideal for use in rough industrial environments
- Insensitive to electromagnetic interference

Selection and ordering data

2 snap-action contacts 1 NO + 1 NC · Degree of protection IP67 · With connecting cable or M12 connector socket

Operating mechanism	Enclosure width mm	DT	Configurator Order No.	Price per PU	PU (UNIT, SET, M)	PS*	PG
Complete units • Enclosure width 30 or 40 mm							
Rounded plungers							
 Rounded plunger	• Standard mounting						
	- With 2 m cable 5 x 0.75 mm ²	30	⊕ A	3SE5 413-0CC20-1EA2	1	1 unit	41K
		40	⊕ A	3SE5 423-0CC20-1EA2	1	1 unit	41K
	- With 5 m cable 5 x 0.75 mm ²	30	⊕ B	3SE5 413-0CC20-1EA5	1	1 unit	41K
	- With M12 connector socket	30	⊕ A	3SE5 413-0CC20-1EB1	1	1 unit	41K
	40	⊕ A	3SE5 423-0CC20-1EB1	1	1 unit	41K	
 With central fixing	• With central fixing M12 x 1						
	- With 2 m cable 5 x 0.75 mm ²	30	⊕ A	3SE5 413-0CC21-1EA2	1	1 unit	41K
	40	⊕ A	3SE5 423-0CC21-1EA2	1	1 unit	41K	
 With external seal	• With external seal						
	- With 2 m cable 5 x 0.75 mm ²	30	⊕ A	3SE5 413-0CC22-1EA2	1	1 unit	41K
	40	⊕ A	3SE5 423-0CC22-1EA2	1	1 unit	41K	
Roller plungers							
 Roller plunger	• Standard mounting						
	- With 2 m cable 5 x 0.75 mm ²	30	⊕ A	3SE5 413-0CD20-1EA2	1	1 unit	41K
		40	⊕ A	3SE5 423-0CD20-1EA2	1	1 unit	41K
	- With 5 m cable 5 x 0.75 mm ²	30	⊕ B	3SE5 413-0CD20-1EA5	1	1 unit	41K
	- With M12 connector socket	30	⊕ A	3SE5 413-0CD20-1EB1	1	1 unit	41K
	40	⊕ A	3SE5 423-0CD20-1EB1	1	1 unit	41K	
 With plug	• With central fixing M12 x 1						
	- With 2 m cable 5 x 0.75 mm ²	30	⊕ A	3SE5 413-0CD21-1EA2	1	1 unit	41K
	40	⊕ A	3SE5 423-0CD21-1EA2	1	1 unit	41K	
 With plug, enclosure width 40 mm	• Actuator head rotated 90°						
	- With 2 m cable 5 x 0.75 mm ²	30	⊕ A	3SE5 413-0CD23-1EA2	1	1 unit	41K
Twist levers							
 Twist lever	• Standard mounting						
	- With 2 m cable 5 x 0.75 mm ²	30	⊕ A	3SE5 413-0CN20-1EA2	1	1 unit	41K
		40	⊕ A	3SE5 423-0CN20-1EA2	1	1 unit	41K
	- With 5 m cable 5 x 0.75 mm ²	30	⊕ A	3SE5 413-0CN20-1EA5	1	1 unit	41K
	- With M12 connector socket	30	⊕ A	3SE5 413-0CN20-1EB1	1	1 unit	41K
	40	⊕ A	3SE5 423-0CN20-1EB1	1	1 unit	41K	

⚙ For online configurator see www.siemens.com/sirius/configurators.

⊕ Positive opening according to IEC 60947-5-1, Appendix K.

SIRIUS 3SE5 Mechanical Position Switches

Open-Type

3SE5, open-type design

Overview



Open-type design





Their compact design makes these switches particularly suitable for use in confined conditions. The fixing dimensions and operating points are according to EN 50047.

The switches are equipped with two or three contacts in slow-action or snap-action versions. The stroke is 6 mm.

The empty enclosure can be equipped with all switch block versions (see page 12/52).

Selection and ordering data

2 or 3 contacts · Degree of protection IP20 (2 contacts), IP10 (3 contacts)

Version	Contacts	DT	Configurator	PU (UNIT, SET, M)	PS*	PG
			Order No.	Price per PU		
Plastic enclosures · Enclosure width 30 mm						
With teflon plunger, Ø 6 mm						
	Slow-action contacts	1 NO + 1 NC	⊕ A	3SE5 250-0BC05	1	1 unit 41K
	Snap-action contacts	1 NO + 1 NC	⊕ ▶	3SE5 250-0CC05	1	1 unit 41K
	Slow-action contacts	1 NO + 2 NC	⊕ B	3SE5 250-0KC05	1	1 unit 41K
	Snap-action contacts	1 NO + 2 NC	⊕ ▶	3SE5 250-0LC05	1	1 unit 41K
	Slow-action contacts with make-before-break	1 NO + 2 NC	⊕ A	3SE5 250-0MC05	1	1 unit 41K
	Slow-action contacts	2 NO + 1 NC	⊕ A	3SE5 250-0PC05	1	1 unit 41K
	Empty enclosures without contact block	--	⊕ B	3SE5 250-0AC05	1	1 unit 41K
	Contact blocks with 2 contacts for open-type design¹⁾					
	• Slow-action contacts	1 NO + 1 NC	⊕ B	3SE5 050-0BA00	1	1 unit 41K
	• Snap-action contacts	1 NO + 1 NC				
	- Standard		⊕ B	3SE5 050-0CA00	1	1 unit 41K
	- 2 × 2 mm switching interval		⊕ B	3SE5 050-0GA00	1	1 unit 41K
- Short stroke		⊕ B	3SE5 050-0NA00	1	1 unit 41K	



















⚙ For online configurator see www.siemens.com/sirius/configurators.

⊕ Positive opening according to IEC 60947-5-1, Appendix K.

¹⁾ Contact blocks with 3 contacts see page 12/52.

Selection and ordering data







The quick-release devices and plug-in connections are used for fast installation and replacement of position switches.

Version	DT	Order No.	Price per PU	PU (UNIT, SET, M)	PS*	PG	
Quick-release devices for enclosure width 40 mm							
		Adapter plates with screws	B	3SY3 110	1	1 unit	41K
		Base plates with locking lever	B	3SY3 027	1	1 unit	41K
		3SY3 110					
		3SY3 027					
Plug-in connections for M20 × 1.5 connecting threads							
		Connector sockets (6-pole + PE), for M20 × 1.5 For max. 250 V, 10 A With 0.75 mm ² connecting cable, plastic, degree of protection IP65, ambient temperature -40 to +90 °C	C	3SY3 131	1	1 unit	41K
		Cable boxes (6-pole + PE)¹⁾ With terminal compartment, can be pre-assembled, plastic, degree of protection IP65	A	3SY3 136	1	1 unit	41K
		Connector sockets (4-pole), M12, for M20 × 1.5, fixed For max 250 V, 4 A, $U_{imp} = 2500$ V With four 0.25 mm ² connecting cables, plastic, degree of protection IP67, ambient temperature -40 to +85 °C	B	3SY3 127	1	1 unit	41K
		Connector sockets (5-pole), M12, for M20 × 1.5, fixed For max. 125 V, 4 A, $U_{imp} = 1500$ V With five 0.25 mm ² connecting cables, plastic, degree of protection IP67, ambient temperature -40 to +85 °C	B	3SY3 128	1	1 unit	41K
		Connector sockets (8-pole), M12, for M20 × 1.5, fixed, metal version for max. 30 V, 2 A, $U_{imp} = 800$ V With eight 0.25 mm ² connecting cables, metal, degree of protection IP67, ambient temperature -40 to +85 °C	C	3SY3 134	1	1 unit	41K
		3SY3 134					
		M12 sockets, angled, 4-pole, for AS-Interface, max 4 A with cabling box, max. 0.75 mm ²	C	3RK1 902-4CA00-4AA0	1	1 unit	42D
		Adapters acc. to , , and  For cable entry from M20 × 1.5 to NPT 1/2	B	3SX9 917	1	1 unit	41K
		• Metal	D	3SX9 918	1	1 unit	41K
		Cable glands M20 × 1.5 Plastic	A	3SX9 926	1	1 unit	41K
		3SX9 926					

¹⁾ For wiring, a crimping tool is necessary, max. conductor cross-section 1 mm².

SIRIUS 3SE5 Mechanical Position Switches

Accessories and spare parts

Version	Color/ contacts	DT	Order No.	Price per PU	PU (UNIT, SET, M)	PS*	PG
Optional accessories for 3SE52							
	Protective caps, rubber for rounded plungers acc. to EN 50047, 3SE5 ...-...C05	Black	A	3SE5 000-0AC30	1	1 unit	41K
Spare parts for 3SE51, 3SE52							
	Empty enclosures, plastic Enclosure width 31 mm • With increased corrosion protection	Turquoise	B	3SE5 232-0AC05	1	1 unit	41K
	Enclosure width 50 mm • With increased corrosion protection		B	3SE5 232-0AC05-1CA0	1	1 unit	41K
			B	3SE5 242-0AC05	1	1 unit	41K
			B	3SE5 242-0AC05-1CA0	1	1 unit	41K
Enclosure width 31 mm							
	Empty enclosures, metal Enclosure width 31 mm • With increased corrosion protection	Turquoise	B	3SE5 212-0AC05	1	1 unit	41K
	Enclosure width 40 mm • With increased corrosion protection		B	3SE5 212-0AC05-1CA0	1	1 unit	41K
	Enclosure width 40 mm		B	3SE5 112-0AA00	1	1 unit	41K
	• With increased corrosion protection		B	3SE5 112-0AA00-1CA0	1	1 unit	41K
	Enclosure width 56 mm		B	3SE5 122-0AA00	1	1 unit	41K
Enclosure width 40 mm	• With increased corrosion protection		B	3SE5 122-0AA00-1CA0	1	1 unit	41K
	Enclosure width 56 mm, XL ¹⁾		B	3SE5 162-0AA00	1	1 unit	41K
	Contact blocks with 2 contacts²⁾ • Slow-action contacts • Snap-action contacts	1 NO + 1 NC 1 NO + 1 NC	⊕ B	3SE5 000-0BA00	1	1 unit	41K
2 contacts	- Standard		⊕ B	3SE5 000-0CA00	1	1 unit	41K
	- Gold-plated contacts		⊕ B	3SE5 000-0CA00-1AC1	1	1 unit	41K
	- 2 × 2 mm switching interval		⊕ B	3SE5 000-0GA00	1	1 unit	41K
	- Short stroke		⊕ B	3SE5 000-0NA00	1	1 unit	41K
	Contact blocks with 3 contacts • Slow-action contacts • Snap-action contacts	1 NO + 2 NC 1 NO + 2 NC	⊕ B	3SE5 000-0KA00	1	1 unit	41K
3 contacts	• Slow-action contacts with make-before-break	1 NO + 2 NC	⊕ A	3SE5 000-0MA00	1	1 unit	41K
	• Slow-action contacts	2 NO + 1 NC	A	3SE5 000-0PA00	1	1 unit	41K
	Contact blocks for enclosure XL¹⁾ • Slow-action contacts • Snap-action contacts	1 NO + 1 NC 1 NO + 1 NC	⊕ B	3SE5 060-0BA00	1	1 unit	41K
2 contacts	• Slow-action contacts with make-before-break	1 NO + 2 NC	⊕ B	3SE5 060-0MA00	1	1 unit	41K

⊕ Positive opening according to IEC 60947-5-1, Appendix K.

¹⁾ Equip XL enclosures only with contact combinations according to pages 12/11, 12/42 and 12/43.

²⁾ Unsuitable for open-type position switches; see page 12/50.

Accessories and spare parts

Version	Rated voltage LED	DT	Order No.	Price per PU	PU (UNIT, SET, M)	PS*	PG
V							
Spare parts for 3SE51, 3SE52							
 31 mm, turquoise with LED	Covers for plastic enclosures, width 31 mm						
	• Turquoise with LED	24 DC	B	3SE5 230-1AA00		1	1 unit 41K
		230 AC	B	3SE5 230-3AA00		1	1 unit 41K
	• Yellow	--	B	3SE5 230-0AA00-1AG0		1	1 unit 41K
	• Yellow with LED	24 DC	B	3SE5 230-1AA00-1AG0		1	1 unit 41K
		230 AC	B	3SE5 230-3AA00-1AG0		1	1 unit 41K
 40 mm, yellow with LED	Covers for plastic enclosures, width 40 mm						
	• Turquoise with LED	24 DC	B	3SE5 130-1AA00		1	1 unit 41K
		230 AC	B	3SE5 130-3AA00		1	1 unit 41K
	• Yellow	--	B	3SE5 130-0AA00-1AG0		1	1 unit 41K
	• Yellow with LED	24 DC	B	3SE5 130-1AA00-1AG0		1	1 unit 41K
		230 AC	B	3SE5 130-3AA00-1AG0		1	1 unit 41K
 50 mm, turquoise with LED	Covers for plastic enclosures, width 50 mm						
	• Turquoise with LED	24 DC	B	3SE5 240-1AA00		1	1 unit 41K
		230 AC	B	3SE5 240-3AA00		1	1 unit 41K
	• Yellow	--	B	3SE5 240-0AA00-1AG0		1	1 unit 41K
	• Yellow with LED	24 DC	B	3SE5 240-1AA00-1AG0		1	1 unit 41K
		230 AC	B	3SE5 240-3AA00-1AG0		1	1 unit 41K
 31 mm, turquoise with LED	Covers for metal enclosures, width 31 mm						
	• Turquoise with LED	24 DC	B	3SE5 210-1AA00		1	1 unit 41K
		230 AC	B	3SE5 210-3AA00		1	1 unit 41K
	• Yellow	--	B	3SE5 210-0AA00-1AG0		1	1 unit 41K
	• Yellow with LED	24 DC	B	3SE5 210-1AA00-1AG0		1	1 unit 41K
		230 AC	B	3SE5 210-3AA00-1AG0		1	1 unit 41K
 40 mm, yellow with LED	Covers for metal enclosures, width 40 mm						
	• Turquoise with LED	24 DC	B	3SE5 110-1AA00		1	1 unit 41K
		230 AC	B	3SE5 110-3AA00		1	1 unit 41K
	• Yellow	--	B	3SE5 110-0AA00-1AG0		1	1 unit 41K
	• Yellow with LED	24 DC	B	3SE5 110-1AA00-1AG0		1	1 unit 41K
		230 AC	B	3SE5 110-3AA00-1AG0		1	1 unit 41K
 56 mm, yellow with LED	Covers for metal enclosures, width 56 mm						
	• Turquoise with LED	24 DC	B	3SE5 120-1AA00		1	1 unit 41K
		230 AC	B	3SE5 120-3AA00		1	1 unit 41K
	• Yellow	--	B	3SE5 120-0AA00-1AG0		1	1 unit 41K
	• Yellow with LED	24 DC	B	3SE5 120-1AA00-1AG0		1	1 unit 41K
		230 AC	B	3SE5 120-3AA00-1AG0		1	1 unit 41K
Covers for XL metal enclosures, width 56 mm							
• Yellow	--	B	3SE5 160-0AA00-1AG0		1	1 unit 41K	

SIRIUS 3SE5, 3SE2 Mechanical Safety Switches

With Separate Actuator

General data

Overview

Position switches with separate actuator are used where the position of doors, covers or protective grills must be monitored for safety reasons.

3SE5 position switches with separate actuator have the same enclosures as the standard switches (modular system).



Position switches with head for separate actuator

Design

Enclosure sizes

The 3SE5 switches are available in various enclosure sizes:

- Plastic enclosures according to EN 50047, 31 mm wide, IP65, 1 cable entry
- Metal enclosures according to EN 50047, 31 mm wide, IP66/IP67, 1 cable entry
- Plastic and metal enclosures according to EN 50041, 40 mm wide, IP66/IP67, 1 cable entry
- Plastic enclosures, 50 mm wide, IP66/IP67, 2 cable entries
- Metal enclosures, 56 mm wide, IP66/IP67, 3 cable entries

Also available is a switch in the 3SE2 series which has arisen in this form according to general market requirements:

- Molded-plastic enclosures outside of the standards, enclosure width 52 mm, IP67

Enclosure versions

Various basic versions can be selected for the enclosures of the 3SE5 series:

- Available with two- or three-pole contact blocks designed as slow-action contacts
- Optional LED status display
- With mounted four- or five-pole M12 connector socket (available for the wide enclosures as an accessory for self-assembly)
- With 6-pole connector socket + PE on the metal enclosures
- Similarly with a combination of connector socket and LED indicators
- Metal enclosures for explosion protection (ATEX) (see page 12/84)
- AS-Interface version with integrated ASIsafe electronics for all enclosure designs (see page 12/94)

For a description of the basic switches, see page 12/4.

Operation

The actuator head is included in the scope of supply. For actuation from four directions it can be adjusted through $4 \times 90^\circ$. The switches can also be approached from above.

The twist actuators of the 3SE2 243 and 3SE2 257 switches with special enclosures cannot be changed. The switches can be approached from the two broad sides and from above.

The actuators are not included in the scope of supply of the position switch and must be ordered separately from various versions to suit the application (see page 12/63).

The actuator is encoded. Simple overruling by hand or auxiliary devices is impossible.

Radius actuators

The position switches with radius actuators are particularly suitable for rotatable protective devices. The movable actuation key allows even small radii to be approached. Damage to the switch and the actuator due to inaccurate approach is prevented.

Locking devices

A high-grade steel blocking insert for attaching up to eight padlocks is available for even more safety (see page 12/63).

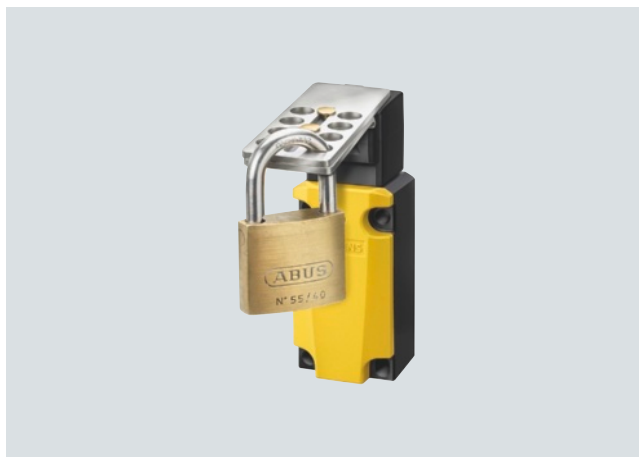

Blocking insert with padlock

Dust protection

A rubber cap to protect the twist actuator from contamination is available for operation in dusty environments (see page 12/63).

Contact reliability

The new contact blocks ensure an extremely high contact stability. This applies even when the devices are switching low voltages and currents, e.g. 1 mA at 5 V DC.

Positive opening

The NC contacts of the switch are forced open mechanically, positively-driven and reliably by the plunger. This is referred to as "positive opening".

SIRIUS 3SE5, 3SE2 Mechanical Safety Switches

With Separate Actuator

General data

Benefits

The 3SE5 position switches with separate actuator differ from the previous series through the following new characteristics:

- All enclosure sizes with increased corrosion protection
- All enclosure sizes are optionally available with a LED signaling indicator.
- The three-pole contact block 1 NO + 2 NC is available for all enclosure sizes.
- The plastic enclosure has simple and fast wiring equipment which makes it possible to save from approx. 20 to 25 % of the time when connecting.
- The ASIsafe electric component is integrated for the versions with the AS-Interface connection (see page 12/94); an adapter is not required.

Application

Position switches with separate actuator are used where the position of doors, covers or protective grills must be monitored for safety reasons.

The position switch can only be operated with the matching coded actuator. Simple overruling by hand or auxiliary devices is impossible.

Devices are available with enclosure versions to suit the particular ambient conditions. Different control tasks can be performed with the best contact blocks suited for the particular purpose. Dimensions, fixing points of the enclosure are in

accordance with EN 50041 or EN 50047 standards. The devices are suitable for use in any climate.

Standards

IEC 60947-5-1 or EN 60947-5-1.

The protective measure of "total insulation" by the molded-plastic enclosure is guaranteed by the use of molded-plastic screw-glands.

Safety position switches

For controls according to IEC 60204-1 or EN 60204-1 the devices can be used as a safety position switch. To secure position switches against changes in their position, keyed techniques must be employed on installation.

Safety circuits

IEC 60947-5-1 and EN 60947-5-1 require positive opening of the NC contacts, i.e. for the purposes of personal safety, the assured opening of NC contacts is expressly stipulated for the electrical equipment of machines in all safety circuits and marked according to the IEC standard 60947-5-1 with the symbol ☞.

Category 3 according to ISO 13849-1 (EN 954-1) can be attained with a position switch with a separate actuator if the corresponding failsafe evaluation units are selected and correctly installed, e.g. the 3TK28 safety relays or matching units from the ASIsafe, SIMATIC or SINUMERIK product ranges.

Category 4 can be achieved when using an additional position switch.

Technical specifications

Type		3SE5 1...-V.., 3SE5 2...-V..	3SE2 257-.XX..	3SE2 243-.XX..
General data				
Standards		IEC 60947-5-1, EN 60947-5-1		
Rated insulation voltage U_i	V	400	500	
Pollution degree acc. to IEC 60664-1		Class 3	Class 3	
Rated impulse withstand voltage U_{imp}	kV	6		
Rated operational voltage U_e	V	400 AC; over 300 V AC only equal potential	500 AC; over 380 V AC only equal potential	
Conventional thermal current I_{th}	A	6	10	
Rated operational current I_e		2-pole	3-pole	1-pole
• With alternating current 50/60 Hz		$I_e/AC-15$	$I_e/AC-15$	$I_e/AC-12$
- At 24 V	A	6	6	10
- At 120 V	A	6	3	10
- At 240 V	A	3	1.5	10
- At 400 V	A	--	--	10
- At 500 V	A	--	--	10
• For direct current		$I_e/DC-13$	$I_e/DC-13$	$I_e/DC-12$
- At 24 V	A	3	3	10
- At 125 V	A	0.55	0.55	--
- At 250 V	A	0.27	0.27	--
- At 110 V	A	--	--	4
- At 220 V	A	--	--	1
- At 440 V	A	--	--	0.5
				$I_e/AC-15$
				$I_e/AC-12$
				$I_e/DC-12$
				$I_e/DC-13$
				$I_e/AC-15$
				$I_e/AC-12$
				$I_e/DC-12$
				$I_e/DC-13$
				$I_e/AC-15$
				$I_e/AC-12$
				$I_e/DC-12$
				$I_e/DC-13$
Short-circuit protection¹⁾				
• With DIAZED fuse links, gG operational class	A	6	6	
• With fuse links, quick	--		10	
• With miniature circuit breaker, Char. C	A	1	2	--
Mechanical endurance		1 × 10 ⁶ operating cycles		
Electrical endurance				
• With 3RH.1, 3RT contactors in size S00, S0		10 × 10 ⁶ operating cycles	> 1 × 10 ⁶ operating cycles	
• For utilization category AC-15 when switching off $I_e/AC-15$ at 240 V		0.1 × 10 ⁶ operating cycles	0.5 × 10 ⁶ operating cycles	
Switching frequency		6000 operating cycles/h		
With 3RH.1, 3RT contactors in size S00, S0				
Minimum pull-out force for positive opening	N	20	10	30

SIRIUS 3SE5, 3SE2 Mechanical Safety Switches With Separate Actuator

General data

3SE51, 3SE52 configuration

Enclosure width 31 mm
3SE5 23.-.QV40, 3SE5 23.-.RV40

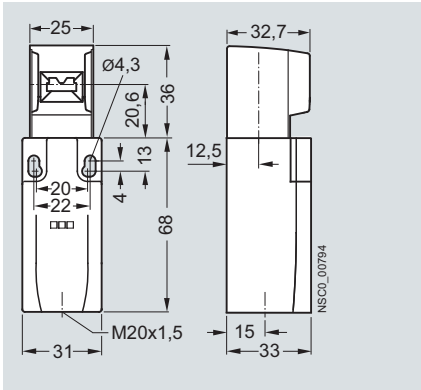

Enclosure width 50 mm
3SE5 24.-.QV40, 3SE5 24.-.RV40

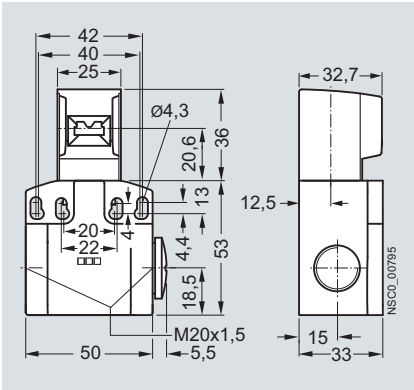

Enclosure width 40 mm
3SE5 11.-.QV10, 3SE5 11.-.RV10

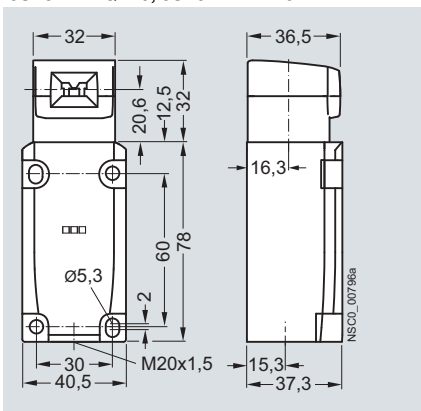

Enclosure width 56 mm
3SE5 12.-.QV10, 3SE5 12.-.RV10

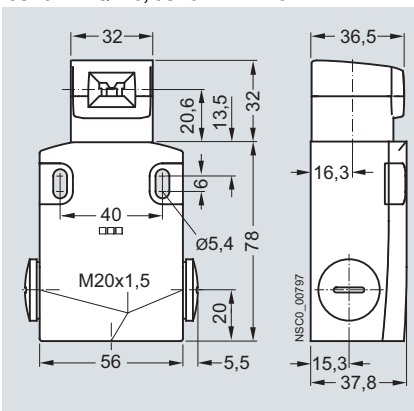

Actuators

Standard actuator
3SE5 000-0AV01

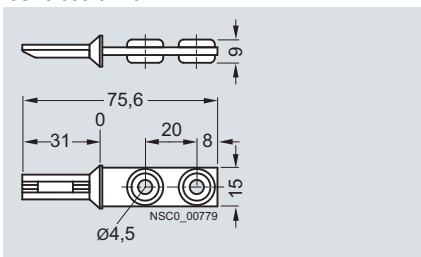

Actuator with vertical fixing
3SE5 000-0AV02

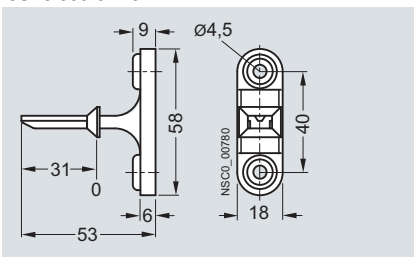

Actuator with horizontal fixing
3SE5 000-0AV03

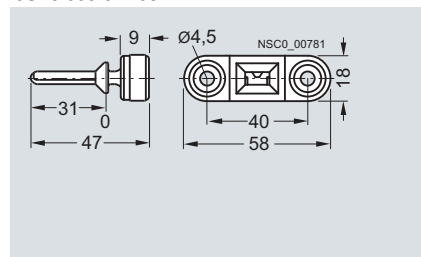

Radius actuator, approach from left
3SE5 000-0AV04

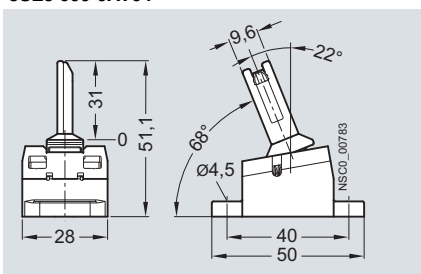

Radius actuator approach from right
3SE5 000-0AV06

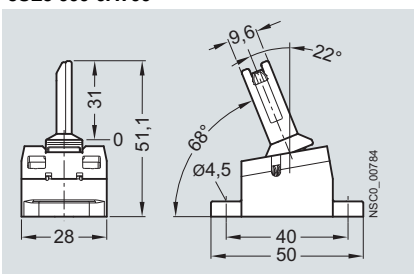

Universal radius actuator
3SE5 000-0AV05

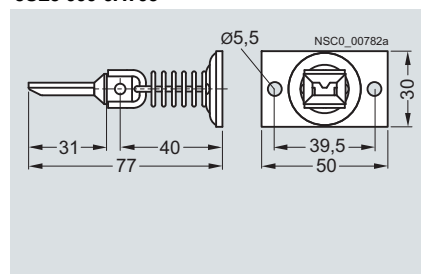

12

SIRIUS 3SE5, 3SE2 Mechanical Safety Switches With Separate Actuator

General data

Universal radius actuator, heavy duty 3SE5 000-0AV07

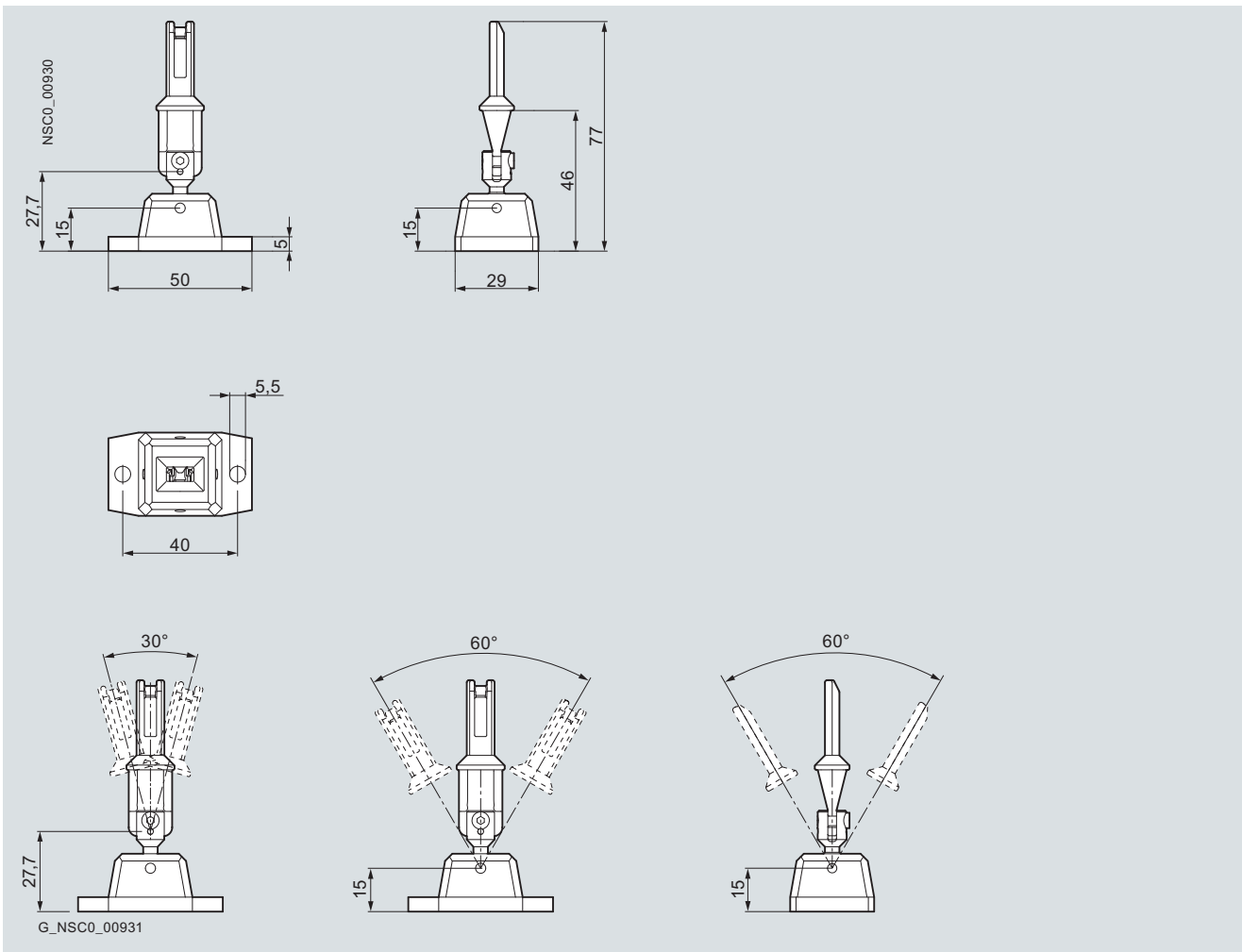

Actuation and travel

Standard actuators

Axial and lateral actuation (4 × 90°)

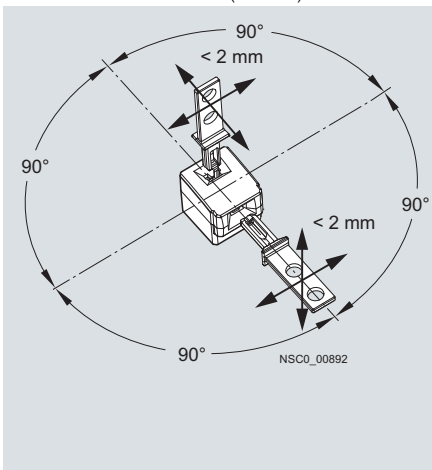

Lateral actuation (4 × 90°)

Slow-action contacts

1 NO + 1 NC, Ident. No. 11

0	1,7	2,5	NSC0_00921	13-14	21-22 **
mm	2,4**			IV 30	

1 NO + 2 NC, Ident. No. 12

0	1,7	2,5	NSC0_00923	13-14	21-22 **	31-32 **
mm	2,4**			IV 30		

Contact closed
 Contact open

Actuator in actuator head:
NC is closed

** Positive opening point

Radius actuators (all directions of approach)

Example: Direction of approach from the left

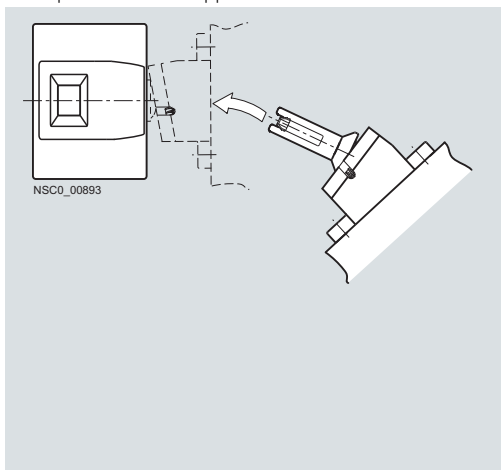

Circuit diagrams and connector assignment see page 12/11.

SIRIUS 3SE5, 3SE2 Mechanical Safety Switches With Separate Actuator

General data

3SE2 243, 3SE2 257 configuration

3SE2 243, lateral and front-end actuation, with 3SX3 218 standard actuator

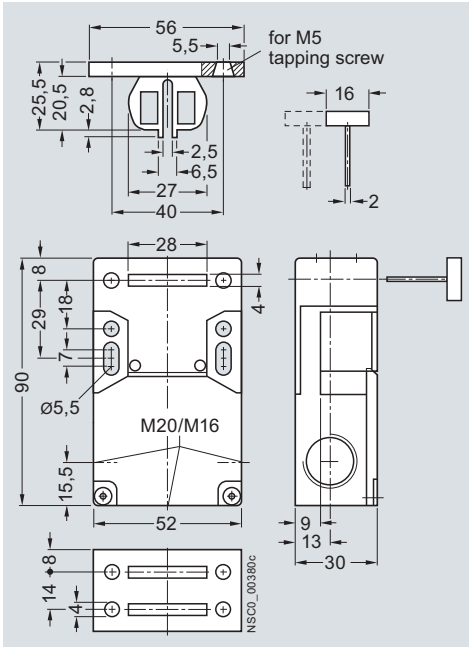

3SE2 257, lateral and front-end actuation

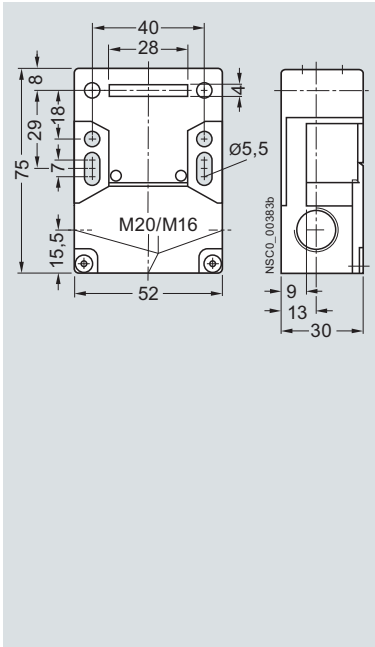

3SX3 228 universal radius actuator

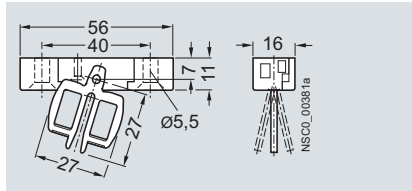

3SX3 217 actuator with ball locating

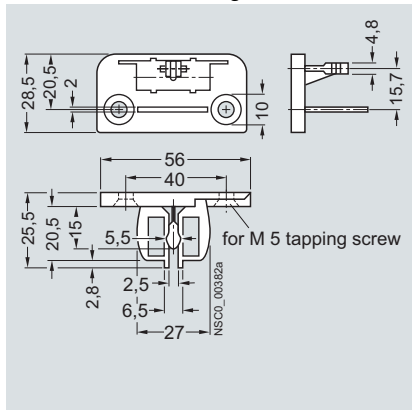

Actuation and travel

Standard and radius actuators

Axial and lateral actuation

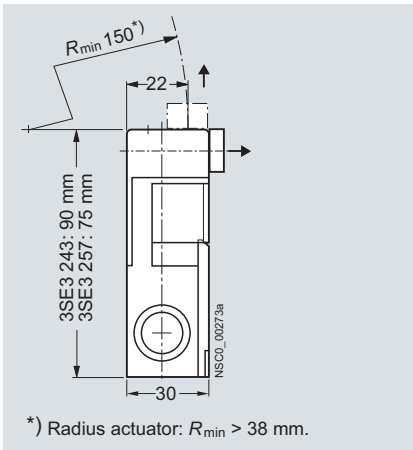

Lateral actuation

Slow-action contacts

1 NC, Ident. No. 01

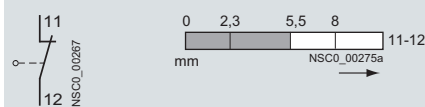

1 NO + 2 NC, Ident. No. 12

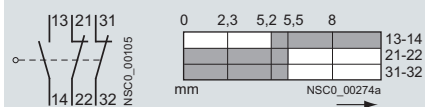

■ Contact closed
□ Contact open

Actuator in actuator head:
NC is closed

SIRIUS 3SE5, 3SE2 Mechanical Safety Switches

With Separate Actuator

3SE5, plastic enclosures
Enclosure width 31 mm acc. to EN 50047 / 50 mm

Selection and ordering data

Complete units

2 or 3 contacts · 5 directions of approach · Degree of protection IP65 (31 mm) or IP66/IP67 (50 mm) · Cable entry M20 × 1.5

Version ¹⁾	Contacts	LEDs	DT	Complete units	PU (UNIT, SET, M)	PS*	PG
				Configurator			
				Order No.	Price per PU		
Enclosure width 31 mm acc. to EN 50047							
	5 directions of approach						
	Slow-action contacts	1 NO + 1 NC --	⊕ B	3SE5 232-0RV40	1	1 unit	41K
	Slow-action contacts	1 NO + 2 NC --	⊕ ▶	3SE5 232-0QV40	1	1 unit	41K
	With increased minimum pull-out force 30 N						
	Slow-action contacts	1 NO + 2 NC --	⊕ B	3SE5 232-0QV40-1AA1	1	1 unit	41K
	With M12 connector socket, 4-pole (250 V, 4 A)						
	Slow-action contacts	1 NO + 1 NC --	⊕ B	3SE5 234-0RV40-1AC4	1	1 unit	41K
	Slow-action contacts	2 NC --	⊕ B	3SE5 234-0QV40-1AE0	1	1 unit	41K
	With 2 LEDs, yellow/green						
	Slow-action contacts	1 NO + 1 NC 24 V DC	⊕ B	3SE5 232-1RV40	1	1 unit	41K
	Slow-action contacts	1 NO + 1 NC 230 V AC	⊕ B	3SE5 232-3RV40	1	1 unit	41K
	With M12 connector socket, 5-pole (125 V, 4 A) and 2 LEDs						
	Slow-action contacts	1 NO + 1 NC 24 V DC	⊕ B	3SE5 234-1RV40-1AF3	1	1 unit	41K
Enclosure width 50 mm							
	5 directions of approach						
	Slow-action contacts	1 NO + 2 NC --	⊕ B	3SE5 242-0QV40	1	1 unit	41K
	With increased minimum pull-out force 30 N						
	Slow-action contacts	1 NO + 1 NC --	⊕ B	3SE5 242-0RV40-1AA1	1	1 unit	41K
	With 2 LEDs, yellow/green						
	Slow-action contacts	1 NO + 2 NC 24 V DC	⊕ B	3SE5 242-1QV40	1	1 unit	41K
	Slow-action contacts	1 NO + 2 NC 230 V AC	⊕ B	3SE5 242-3QV40	1	1 unit	41K

For online configurator see www.siemens.com/sirius/configurators.

⊕ Positive opening according to IEC 60947-5-1, Appendix K.

¹⁾ Supplied without actuator. Please order separately (see page 12/63).

SIRIUS 3SE5, 3SE2 Mechanical Safety Switches



With Separate Actuator

3SE5, plastic enclosures
Enclosure width 40 mm acc. to EN 50041

Selection and ordering data

Complete units

2 or 3 contacts · 5 directions of approach · Degree of protection IP66/IP67 · Cable entry M20 × 1.5

Version ¹⁾	Contacts	LEDs	DT	Complete units	PU (UNIT, SET, M)	PS*	PG
				Configurator			
				Order No.	Price per PU		
Enclosure width 40 mm acc. to EN 50041							
	5 directions of approach						
	Slow-action contacts	1 NO + 2 NC --	⊕ B	3SE5 132-0QV20	1	1 unit	41K
With separate actuator	With 2 LEDs, yellow/green						
	Slow-action contacts	1 NO + 2 NC 24 V DC	⊕ C	3SE5 132-1QV20	1	1 unit	41K
With 2 LEDs	Slow-action contacts	1 NO + 2 NC 230 V AC	⊕ C	3SE5 132-3QV20	1	1 unit	41K

For online configurator see www.siemens.com/sirius/configurators.

⊕ Positive opening according to IEC 60947-5-1, Appendix K.

¹⁾ Supplied without actuator. Please order separately (see page 12/63).

SIRIUS 3SE5, 3SE2 Mechanical Safety Switches

With Separate Actuator

3SE5, metal enclosures
Enclosure width 31 mm acc. to EN 50047



Selection and ordering data

Complete units

2 or 3 contacts · 5 directions of approach · Degree of protection IP66/IP67 · Cable entry M20 × 1.5

Version ¹⁾	Contacts	LEDs	DT	Complete units	<input type="checkbox"/>	PU (UNIT, SET, M)	PS*	PG
				Configurator				
				Order No.		Price per PU		

Enclosure width 31 mm acc. to EN 50047

5 directions of approach									
	Slow-action contacts	1 NO + 1 NC --	⊕ A	3SE5 212-0RV40	1	1 unit	41K		
	Slow-action contacts	1 NO + 2 NC --	⊕ B	3SE5 212-0QV40	1	1 unit	41K		
With separate actuator									
With 2 LEDs, yellow/green									
	Slow-action contacts	1 NO + 1 NC 24 V DC	⊕ B	3SE5 212-1RV40	1	1 unit	41K		
	Slow-action contacts	1 NO + 1 NC 230 V AC	⊕ B	3SE5 212-3RV40	1	1 unit	41K		
With 2 LEDs									

For online configurator see www.siemens.com/sirius/configurators.

Positive opening according to IEC 60947-5-1, Appendix K.

¹⁾ Supplied without actuator. Please order separately (see page 12/63).

SIRIUS 3SE5, 3SE2 Mechanical Safety Switches

With Separate Actuator

3SE5, metal enclosures
Enclosure width 40 mm acc. to EN 50041 / 56 mm

Selection and ordering data

Complete units

2 or 3 contacts · 5 directions of approach · Degree of protection IP66/IP67 · Cable entry M20 × 1.5

Version ¹⁾	Contacts	LEDs	DT	Complete units	PU (UNIT, SET, M)	PS*	PG
				Configurator			
				Order No.	Price per PU		
Enclosure width 40 mm acc. to EN 50041							
	5 directions of approach						
	Slow-action contacts	1 NO + 2 NC --	⊕ ▶	3SE5 112-0QV10	1	1 unit	41K
	With increased minimum pull-out force 30 N						
	Slow-action contacts	1 NO + 2 NC --	⊕ B	3SE5 112-0QV10-1AA7	1	1 unit	41K
	With M12 connector socket, 5-pole (125 V, 4 A)						
	Slow-action contacts	1 NO + 1 NC --	⊕ B	3SE5 114-0RV10-1AC5	1	1 unit	41K
	Slow-action contacts	2 NC --	⊕ B	3SE5 114-0QV10-1AE1	1	1 unit	41K
	With connector socket, 6-pole + PE (250 V, 10 A)						
	Slow-action contacts	1 NO + 2 NC --	⊕ B	3SE5 115-0QV10-1AD1	1	1 unit	41K
	With 2 LEDs, yellow/green						
	Slow-action contacts	1 NO + 2 NC 24 V DC	⊕ B	3SE5 112-1QV10	1	1 unit	41K
	Slow-action contacts	1 NO + 2 NC 230 V AC	⊕ B	3SE5 112-3QV10	1	1 unit	41K
	With M12 connector socket, 5-pole (125 V, 4 A) and 2 LEDs						
	Slow-action contacts	1 NO + 1 NC 24 V DC	⊕ B	3SE5 114-1RV10-1AF3	1	1 unit	41K
	With connector socket, 6-pole + PE (10 A), and 2 LEDs						
	Slow-action contacts	1 NO + 1 NC 24 V DC	⊕ B	3SE5 115-1RV10-1AF2	1	1 unit	41K
Enclosure width 56 mm							
	5 directions of approach						
	Slow-action contacts	1 NO + 2 NC --	⊕ B	3SE5 122-0QV10	1	1 unit	41K
	With increased minimum pull-out force 30 N						
	Slow-action contacts	1 NO + 2 NC --	⊕ B	3SE5 122-0QV10-1AA7	1	1 unit	41K
	With 2 LEDs, yellow/green						
	Slow-action contacts	1 NO + 2 NC 24 V DC	⊕ B	3SE5 122-1QV10	1	1 unit	41K
	Slow-action contacts	1 NO + 2 NC 230 V AC	⊕ B	3SE5 122-3QV10	1	1 unit	41K

For online configurator see www.siemens.com/sirius/configurators.

⊕ Positive opening according to IEC 60947-5-1, Appendix K.











¹⁾ Supplied without actuator. Please order separately (see page 12/63).

SIRIUS 3SE5, 3SE2 Mechanical Safety Switches

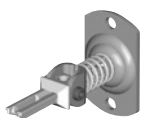
With Separate Actuator

Accessories

Selection and ordering data

Version	DT	Order No.	Price per PU	PU (UNIT, SET, M)	PS*	PG
Actuators for 3SE51, 3SE52						
 3SE5 000-0AV01		Standard actuators, length 75.6 mm	▶	3SE5 000-0AV01	1	1 unit 41K
 3SE5 000-0AV02	A	With vertical fixing, length 53 mm		3SE5 000-0AV02	1	1 unit 41K
 3SE5 000-0AV03	A	With transverse fixing, length 47 mm		3SE5 000-0AV03	1	1 unit 41K
 3SE5 000-0AW11	B	With transverse fixing, plastic ¹⁾ Length 40 mm		3SE5 000-0AW11	1	1 unit 102
 3SE5 000-0AV06	A	Radius actuators, length 51 mm		3SE5 000-0AV04	1	1 unit 41K
	A	<ul style="list-style-type: none"> Direction of approach from the left Direction of approach from the right 		3SE5 000-0AV06	1	1 unit 41K
 3SE5 000-0AV05-1AA6	A	Universal radius actuators		3SE5 000-0AV05	1	1 unit 41K
	A	<ul style="list-style-type: none"> Length 77 mm Length 77 mm, tab rotated 90° 		3SE5 000-0AV05-1AA6	1	1 unit 41K
 3SE5 000-0AV07	A	Universal radius actuators, heavy-duty		3SE5 000-0AV07-1AK2	1	1 unit 41K
	A	<ul style="list-style-type: none"> Length 67 mm Length 77 mm 		3SE5 000-0AV07	1	1 unit 41K
Optional accessories for 3SE5						
 3SE5 000-0AV08-1AA2	B	Protective caps made of black rubber for the actuator head, to protect the actuator openings from contamination (Only for enclosure width 40 or 56 mm)		3SE5 000-0AV08-1AA2	1	1 unit 41K
 3SE5 000-0AV08-1AA3	C	Blocking inserts , high-grade steel, for actuator head, for up to 8 padlocks		3SE5 000-0AV08-1AA3	1	1 unit 41K
Connections for 3SE5, 3SE2						
 3SY3 127	B	Connector sockets (4-pole), M12, fixed for M20 x 1.5 For max. 250 V, 4 A With 0.25 mm ² connecting cable, plastic, degree of protection IP67, ambient temperature -40 to +85 °C		3SY3 127	1	1 unit 41K
	B	Connector sockets (5-pole), M12, fixed for M20 x 1.5 For max. 125 V, 4 A With 0.25 mm ² connecting cable, plastic, degree of protection IP67, ambient temperature -40 to +85 °C		3SY3 128	1	1 unit 41K
 3SX9 926	A	Cable glands M20 x 1.5 Plastic		3SX9 926	1	1 unit 41K

¹⁾ Not suitable for safety switches with interlocking.

SIRIUS 3SE5, 3SE2 Mechanical Safety Switches

With Separate Actuator

3SE2, plastic enclosures
Enclosure width 52 mm

Selection and ordering data

Complete units

1 or 3 contacts · 3 directions of approach · Degree of protection IP67

Version	Operation	DT	Complete units	PU (UNIT, SET, M)	PS*	PG	
			Order No.	Price per PU			
Molded-plastic enclosures in special width of 52 mm							
	Lateral and front-end actuation¹⁾	6 mm stroke					
	• With M20 × 1.5 connecting thread						
	- Slow-action contacts 1 NO + 2 NC	Holding force 5 N	⊙ ▶	3SE2 243-0XX40	1	1 unit	41K
		Holding force 30 N	⊙ ▶	3SE2 243-0XX	1	1 unit	41K
		With automatic ejection	⊙ ▶	3SE2 243-0XX30	1	1 unit	41K
	- Slow-action contacts 1 NC	Holding force 5 N	⊙ ▶	3SE2 257-6XX40	1	1 unit	41K
		Holding force 30 N	⊙ ▶	3SE2 257-6XX	1	1 unit	41K
		With automatic ejection	⊙ B	3SE2 257-6XX30	1	1 unit	41K
	• With M16 × 1.5 connecting thread						
	- Slow-action contacts 1 NO + 2 NC	Holding force 5 N	⊙ B	3SE2 243-0XX48	1	1 unit	41K
		Holding force 30 N	⊙ A	3SE2 243-0XX18	1	1 unit	41K
		With automatic ejection	⊙ C	3SE2 243-0XX38	1	1 unit	41K
- Slow-action contacts 1 NC	Holding force 5 N	⊙ B	3SE2 257-6XX48	1	1 unit	41K	
	Holding force 30 N	⊙ C	3SE2 257-6XX18	1	1 unit	41K	
	With automatic ejection	⊙ C	3SE2 257-6XX38	1	1 unit	41K	
Accessories							
	Actuators						
	• Standard actuators ($r_{\min} = 150$ mm), length 28 mm		A	3SX3 218	1	1 unit	41K
3SX3 218							
	• Universal radius actuator ($r_{\min} = 45$ mm), length 34 mm		A	3SX3 228	1	1 unit	41K
3SX3 228							
	• Radius actuator, adjustable radius, length 34 mm		D	3SX3 256	1	1 unit	41K
3SX3 256							
	• Ball locating, force adjustable up to 100 N by 2 screws, length 28 mm		A	3SX3 217	1	1 unit	41K
3SX3 217							
	• Actuator, length 34 mm, with dust protection and slit cover		D	3SX3 234	1	1 unit	41K
3SX3 234							
	Accessories						
	• Slit cover (1 set = 3 units)		D	3SX3 233	1	3 units	41K

⊙ Positive opening according to IEC 60947-5-1, Appendix K.

¹⁾ Supplied without actuator.

SIRIUS 3SE5, 3SE2 Mechanical Safety Switches

With Solenoid Interlocking

General data

Overview

The position switches with solenoid interlocking are exceptional safety-related devices which prevent an unforeseen or intentional opening of protective doors, protective grills or other covers as long as a dangerous situation is present (i.e. follow-on motion of the switched off machine).



Position switches with solenoid interlocking

The safety position switches with solenoid interlocking are comprised of a switch part with electromechanical interlock and a mechanical actuator which has to be ordered separately.

They are rugged protective devices that enable the greatest possible safety for man and machine.

The position switches with solenoid interlocking are offered in plastic or metal enclosures.

Dimensions (W × H × D):

- 3SE5 3: 54 mm × 185 mm × 43.5 mm

Operation

The actuator head is included in the scope of supply. For actuation from four directions it can be adjusted through $4 \times 90^\circ$. The 3SE5 3 switches can also be approached from above.

The actuators are not included in the scope of supply of the position switch and must be ordered separately from various versions to suit the application (see page 12/71).

Actuation data:

- Maximum actuating speed $v_{\max} = 1.5 \text{ m/s}$
- Minimum actuating speed $v_{\min} = 0.4 \text{ mm/s}$
- Minimum force in the direction of actuation $F_{\min} = 30 \text{ N}$

The actuator is encoded. Simple overruling by hand or auxiliary devices is impossible.

Radius actuators

The position switches with radius actuators are particularly suitable for rotatable protective devices. The movable actuation key allows even small radii to be approached. Damage to the switch and the actuator due to inaccurate approach is prevented.

Locking devices

A high-grade steel locking device for attaching up to eight padlocks is available for even more safety (see page 12/71).

Dust protection

A rubber cap to protect the twist actuator from contamination is available for operation in dusty environments (see page 12/71).

Solenoid interlocking

There are two versions for interlocking the actuator:

- Spring-actuated lock (closed-circuit principle) with various release mechanisms
- Solenoid-locked (open-circuit principle)

The spring-actuated lock switch is equipped with an auxiliary release for emergency situations or setup mode. Available as options:

- Escape release or
- Emergency release

Contact blocks

The position switches with solenoid interlocking have one contact block each for:





- Monitoring the actuator or the position of the protective door
- Monitoring the position of the solenoid

The mechanical design of the switch corresponds to the requirements of the failsafe principle according to EN 1088.

Optical signaling equipment

The position switches with solenoid interlocking are available with an optional optical signaling device.

The signaling device indicates the switch position of the lock and the protective device optically by means of 2 LEDs on the front.

Protective device	Solenoid interlocking	Display	Meaning
Closed	Released	 	Actuator to be pulled
Closed	Locked		Actuator locked
Open	Released		Actuator pulled

Note:

The voltage of the LEDs at the monitored contacts must be the same as the operational voltage of the solenoid (same potential).

SIRIUS 3SE5, 3SE2 Mechanical Safety Switches

With Solenoid Interlocking

General data

Benefits

The range of 3SE5 3 position switches offers:

- More safety through higher locking forces:
 - 1300 N with plastic enclosure
 - 2600 N with metal enclosure
- Various release mechanisms: Lock release, escape release and emergency release
- Two contact blocks each with three contacts as standard equipment, hence fewer versions needed
- Same dimensions for all enclosure versions: Plastic, metal or with integrated ASIsafe
- An extensive range of actuators
- An optional LED status display 24 V DC, 115 V AC or 230 V AC for all switch versions
- Devices with ASIsafe electronics integrated in the enclosure (see page 12/98).

Application

The position switches with solenoid interlocking are exceptional safety-related devices which prevent an unforeseen or intentional opening of protective doors, protective grills or other covers as long as a dangerous situation is present (i.e. follow-on motion of the switched off machine).

The safety position switches with solenoid interlocking have the following functions:

- Enabling the machine or process with closed and locked protective device
- Locking the machine or process with opened protective device
- Position monitoring of the protective device and tumbler

Standards

The switches comply with the standards IEC 60947-1 (Low-Voltage Switchgear and Controlgear, General) and IEC 60947-5-1 (Electromechanical Control Circuit Devices).

The mechanical design of the switch corresponds to the requirements of the failsafe principle according to EN 1088.

Approvals

The switches are approved for use with locking devices according to EN 1088 and EN 292, Parts 1 and 2.

3SE5 3 position switches with solenoid interlocking bear the VDE test mark for tested according to GS-ET19 (Test Principles of the German Trade Association for Locking Devices with Electromagnetic Interlocks).

Category 3 according to ISO 13849-1 (EN 954-1) can be attained with a position switch with solenoid interlocking if the corresponding failsafe evaluation units are selected and correctly installed, e.g. the 3TK28 safety relays or matching units from the ASIsafe, SIMATIC or SINUMERIK product ranges.

Category 4 can be achieved when using an additional position switch.

These switches are approved according to UL 508, UL 50 and UL 746-C.

Solenoid interlocking

The separate actuator operates in a similar way to the coding of a key and protects against manipulation. It transmits the locking force to the protective device and helps to monitor its position.

There are two versions of locking:

Spring-actuated lock (closed-circuit principle)

- In the standard version, the position switch locks by means of spring force and releases by means of electromagnetic force. In the case of voltage failure, it reliably prevents the protective device from opening when machine parts are still moving.
- The switch is equipped with an auxiliary release for emergency situations or setup mode.
- An auxiliary release which can be secured with a lock to prevent misuse is available as a version.

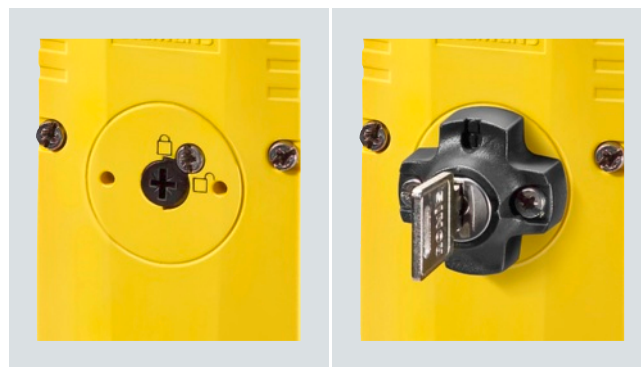

Auxiliary release

Auxiliary release with lock

The 3SE5 3 position switches are also available with an escape release or emergency release.

- Personnel working inside the hazard zone can use the escape release feature to manually release the interlocking without tools from the escape side (hazardous area side) so that they can exit the hazard area. An intentional act (in this case pulling the gray actuator) is required to release the locking mechanism and restore the normal operating state.
- The emergency release enables someone in an emergency situation to manually release the interlock without tools from the access side (outside the hazardous area). Releasing the lock and restoring the normal operating state must require effort which is comparable to repair activity, in this case disassembly of the red actuator and resetting the mechanical lock.

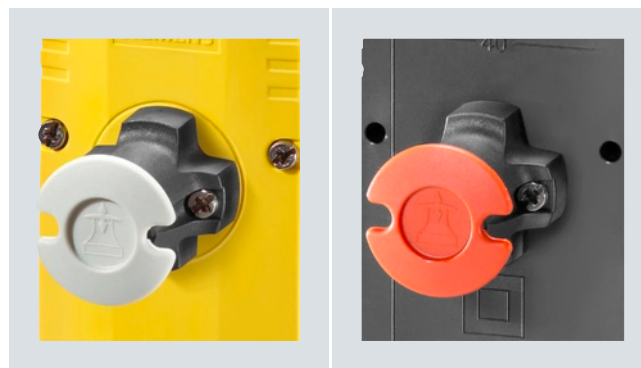

Escape release from the front

Emergency release from the back

Solenoid-locked (open-circuit principle)

- The second version offers locking by means of electromagnetic force and release by means of spring force. This version has an advantage when it is necessary to quickly access the machine after a power failure occurs, or in the case of very short coasting times.

SIRIUS 3SE5, 3SE2 Mechanical Safety Switches

With Solenoid Interlocking

General data

Examples of door interlocking



X-Lock door interlocking from Axelent

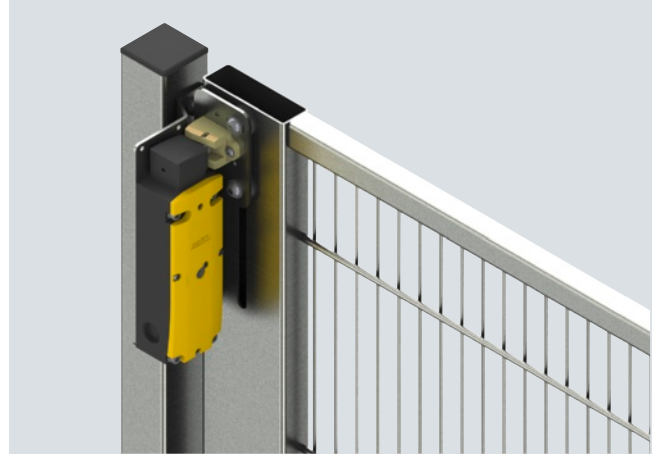

Door interlocking from Brühl

For the addresses of the door interlock manufacturers see Chapter 16, "Appendix" → "External Partners".

Technical specifications

Type		3SE5 322	3SE5 312
General data			
Standards		IEC 60947-5-1, EN 60947-5-1	
Rated insulation voltage U_i	V	250	
Pollution degree acc. to IEC 60664-1		Class 3	
Rated impulse withstand voltage U_{imp}	kV	4	
Rated operational voltage U_e			
• DC	V	24	
• 50/60 Hz AC	V	230	
Conventional thermal current I_{th}	A	6	
Rated operational current I_e			
• With alternating current 50/60 Hz		I_e / AC-15 or B300	
- At 24 V	A	6	
- At 120 V	A	3	
- At 230 V	A	1.5	
• For direct current		I_e / DC-13 or Q300	
- At 24 V	A	3	
- At 125 V	A	0.55	
- At 250 V	A	0.27	
- At 60 V		--	
- At 110 V		--	
- At 220 V		--	
Solenoid			
• Locking force, max.	N	1300	2600
• Locking force acc. to GS-ET 19	N	1000	2000
• Power consumption at U_c	W	3.5	
Short-circuit protection¹⁾			
• With DIAZED fuse links, gG operational class	A	6	
• With fuse links, quick		--	
• With miniature circuit breaker, Char. C	A	0.5	
Mechanical endurance		1 × 10 ⁶ operating cycles	
Electrical endurance			
• With 3RH.1, 3RT contactors in size S00, S0		1 × 10 ⁶ operating cycles	
• For utilization category AC-15 with interrupting of I_e / AC-15 at 230 V		1 × 10 ⁵ operating cycles	
• With utilization category DC-12/DC-13		For direct current depending on the loading of the switch	
Switching frequency With 3RH.1, 3RT contactors in size S00, S0		6000 operating cycles/h	
Shock resistance acc. to IEC 60068-2-27		30 g/11 ms	

SIRIUS 3SE5, 3SE2 Mechanical Safety Switches With Solenoid Interlocking

General data

3SE53 configuration

Spring-actuated lock, with auxiliary release
3SE5 322-.SD2., 3SE5 322-.SG2., 3SE5 322-.SJ2.,
3SE5 312-.SD1., 3SE5 312-.SG1., 3SE5 312-.SJ1.,

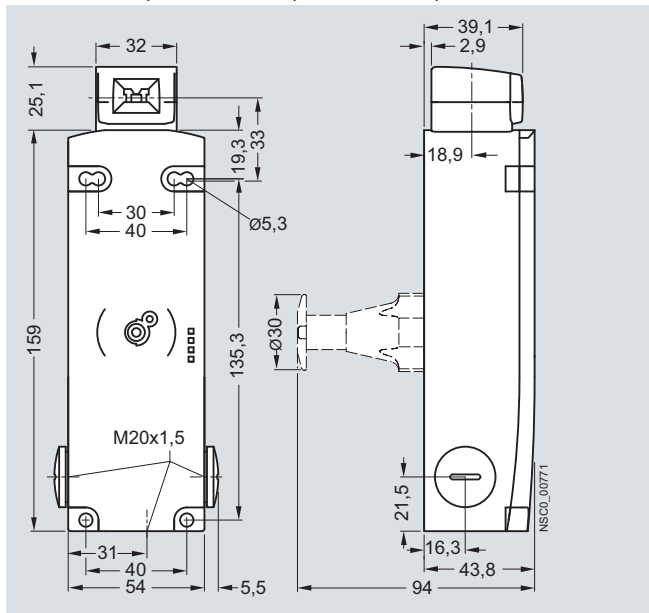

Spring-actuated lock, with auxiliary release with lock
3SE5 322-.SE2.,
3SE5 312-.SE1.

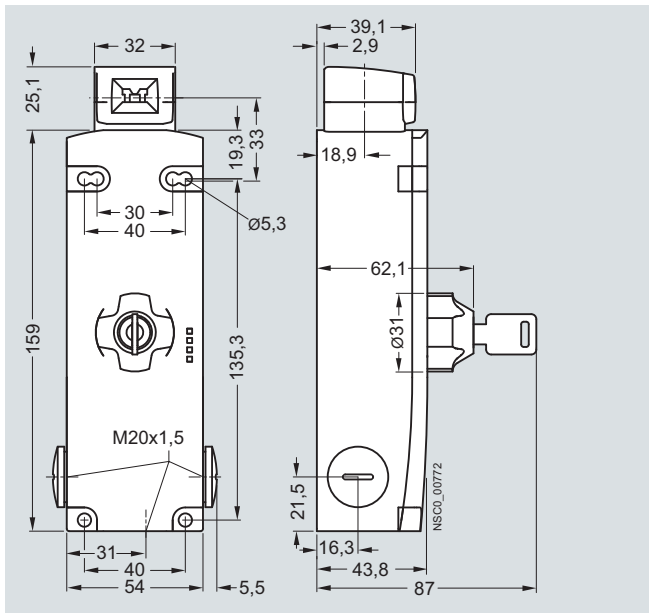

Spring-actuated lock, with escape release
3SE5 322-.SF2.,
3SE5 312-.SF1.

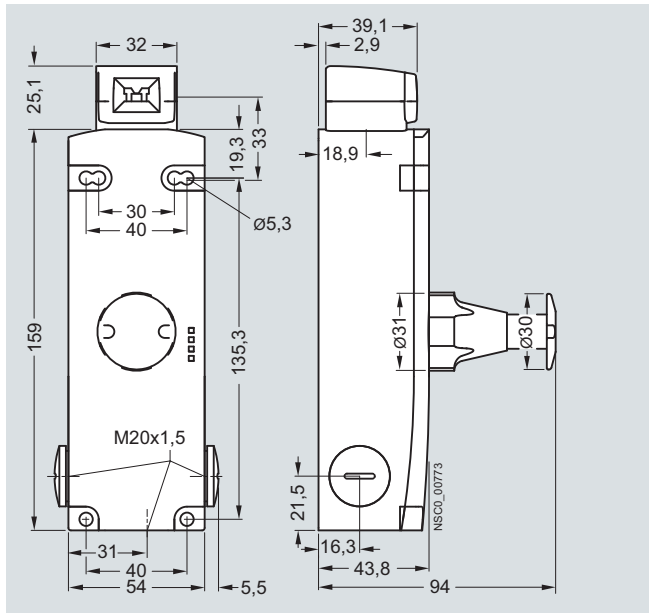

Solenoid lock
3SE5 322-.SB2.,
3SE5 312-.SB1.

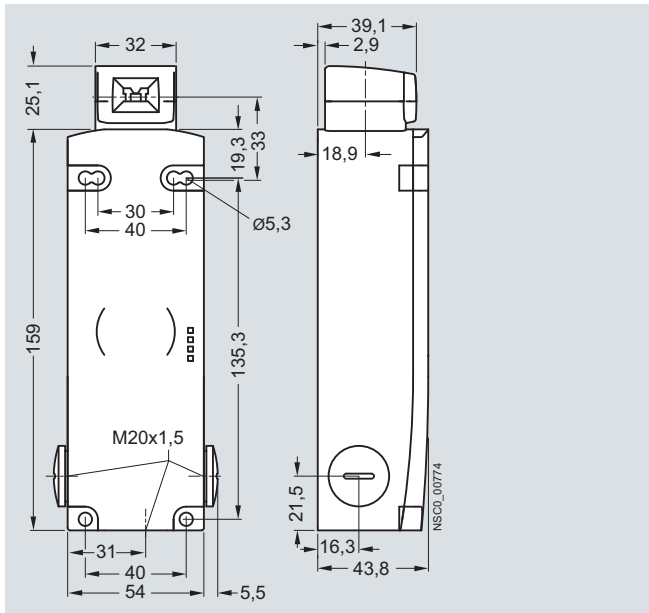

Note:

The plastic enclosures have knock-out openings behind the connecting thread; they are delivered therefore without protective caps.

Circuit diagrams

Monitoring the actuator

Slow-action contacts 1 NO + 2 NC

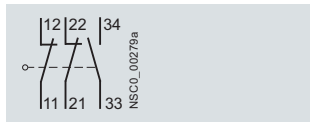

Monitoring the solenoid

Slow-action contacts 1 NO + 2 NC

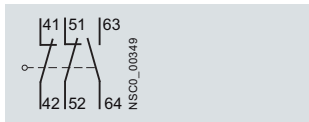

Actuators [see page 12/56](#).

Actuation [see page 12/57](#).

Operating travel

Monitoring the actuator

Slow-action contacts 1 NO + 2 NC

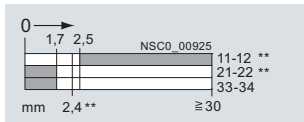

SIRIUS 3SE5, 3SE2 Mechanical Safety Switches

With Solenoid Interlocking

3SE5, plastic enclosures
With locking force greater than 1200 N

Selection and ordering data

6 slow-action contacts · 5 directions of approach · Degree of protection IP66/IP67 · Cable entry 3 × M20 × 1.5
 Locking force 1300 N (1000 N according to GS-ET 19)

Interlock ¹⁾	LEDs	Solenoid, rated operational voltage	DT	Complete units Position monitoring: Actuators: 1 NO + 2 NC Solenoid: 1 NO + 2 NC	PU (UNIT, SET, M)	PS*	PG
				Configurator			
				Order No.	Price per PU		

1300 N locking force · Enclosure width 54 mm

	Spring-actuated locks • With auxiliary release	--	24 DC	⊕ ▶	3SE5 322-0SD21	1	1 unit	41K	
		--	115 AC	⊕ B	3SE5 322-0SD22	1	1 unit	41K	
		--	230 AC	⊕ B	3SE5 322-0SD23	1	1 unit	41K	
		Yellow/Green	24 DC	⊕ A	3SE5 322-1SD21	1	1 unit	41K	
		Yellow/Green	115 AC	⊕ B	3SE5 322-2SD22	1	1 unit	41K	
		Yellow/Green	230 AC	⊕ B	3SE5 322-3SD23	1	1 unit	41K	
	• With auxiliary release with lock	--	24 DC	⊕ B	3SE5 322-0SE21	1	1 unit	41K	
		--	115 AC	⊕ B	3SE5 322-0SE22	1	1 unit	41K	
		--	230 AC	⊕ B	3SE5 322-0SE23	1	1 unit	41K	
		Yellow/Green	24 DC	⊕ B	3SE5 322-1SE21	1	1 unit	41K	
		Yellow/Green	115 AC	⊕ B	3SE5 322-2SE22	1	1 unit	41K	
		Yellow/Green	230 AC	⊕ B	3SE5 322-3SE23	1	1 unit	41K	
	• With escape release from the front	--	24 DC	⊕ B	3SE5 322-0SF21	1	1 unit	41K	
		--	115 AC	⊕ B	3SE5 322-0SF22	1	1 unit	41K	
		--	230 AC	⊕ B	3SE5 322-0SF23	1	1 unit	41K	
		Yellow/Green	24 DC	⊕ B	3SE5 322-1SF21	1	1 unit	41K	
		Yellow/Green	115 AC	⊕ B	3SE5 322-2SF22	1	1 unit	41K	
		Yellow/Green	230 AC	⊕ B	3SE5 322-3SF23	1	1 unit	41K	
	• With escape release from the front and emergency release from the back - For ambient temperature up to -40 °C	--	24 DC	⊕ B	3SE5 322-0SL21	1	1 unit	41K	
		--	24 DC	⊕ B	3SE5 322-0SL21-1AJ0	1	1 unit	41K	
	• With escape release from the back and auxiliary release from the front	--	24 DC	⊕ B	3SE5 322-0SG21	1	1 unit	41K	
		--	115 AC	⊕ B	3SE5 322-0SG22	1	1 unit	41K	
		--	230 AC	⊕ B	3SE5 322-0SG23	1	1 unit	41K	
		Yellow/Green	24 DC	⊕ B	3SE5 322-1SG21	1	1 unit	41K	
		Yellow/Green	115 AC	⊕ B	3SE5 322-2SG22	1	1 unit	41K	
		Yellow/Green	230 AC	⊕ B	3SE5 322-3SG23	1	1 unit	41K	
	• With escape release from the back and auxiliary release with lock from the front	--	24 DC	⊕ B	3SE5 322-0SH21	1	1 unit	41K	
		• With emergency release from the back and auxiliary release from the front	--	24 DC	⊕ B	3SE5 322-0SJ21	1	1 unit	41K
			--	115 AC	⊕ B	3SE5 322-0SJ22	1	1 unit	41K
			--	230 AC	⊕ B	3SE5 322-0SJ23	1	1 unit	41K
		Yellow/Green	24 DC	⊕ B	3SE5 322-1SJ21	1	1 unit	41K	
		Yellow/Green	115 AC	⊕ B	3SE5 322-2SJ22	1	1 unit	41K	
Yellow/Green	230 AC	⊕ B	3SE5 322-3SJ23	1	1 unit	41K			
	Solenoid locks	--	24 DC	⊕ ▶	3SE5 322-0SB21	1	1 unit	41K	
		--	115 AC	⊕ B	3SE5 322-0SB22	1	1 unit	41K	
		--	230 AC	⊕ B	3SE5 322-0SB23	1	1 unit	41K	
		Yellow/Green	24 DC	⊕ A	3SE5 322-1SB21	1	1 unit	41K	
		Yellow/Green	115 AC	⊕ B	3SE5 322-2SB22	1	1 unit	41K	
		Yellow/Green	230 AC	⊕ B	3SE5 322-3SB23	1	1 unit	41K	

⊕ For online configurator see www.siemens.com/sirius/configurators.

⊕ Positive opening according to IEC 60947-5-1, Appendix K.

¹⁾ Supplied without actuator. Please order separately (see page 12/71).

SIRIUS 3SE5, 3SE2 Mechanical Safety Switches

With Solenoid Interlocking

3SE5, metal enclosures
With locking force greater than 2000 N

Selection and ordering data

6 slow-action contacts · 5 directions of approach · Degree of protection IP66/IP67 · Cable entry 3 × M20 × 1.5
Locking force 2600 N (2000 N according to GS-ET 19)

Interlock ¹⁾	LEDs	Solenoid, rated operational voltage	DT	Complete units Position monitoring: Actuators: 1 NO + 2 NC Solenoid: 1 NO + 2 NC	PU (UNIT, SET, M)	PS*	PG
				Configurator			
				Order No.	Price per PU		
V							
2600 N locking force · Enclosure width 54 mm							
Spring-actuated locks							
 3SE5 312-0SD1.1	• With auxiliary release	--	24 DC	⊙ ▶	3SE5 312-0SD11	1	1 unit 41K
		--	115 AC	⊙ B	3SE5 312-0SD12	1	1 unit 41K
		--	230 AC	⊙ B	3SE5 312-0SD13	1	1 unit 41K
	Yellow/Green	--	24 DC	⊙ B	3SE5 312-1SD11	1	1 unit 41K
		--	115 AC	⊙ B	3SE5 312-2SD12	1	1 unit 41K
		--	230 AC	⊙ B	3SE5 312-3SD13	1	1 unit 41K
 3SE5 312-0SE1.1	• With auxiliary release with lock	--	24 DC	⊙ B	3SE5 312-0SE11	1	1 unit 41K
		--	115 AC	⊙ B	3SE5 312-0SE12	1	1 unit 41K
		--	230 AC	⊙ B	3SE5 312-0SE13	1	1 unit 41K
		--	48 AC/DC	⊙ C	3SE5 312-0SE14	1	1 unit 41K
	Yellow/Green	--	24 DC	⊙ B	3SE5 312-1SE11	1	1 unit 41K
		--	115 AC	⊙ B	3SE5 312-2SE12	1	1 unit 41K
 3SE5 312-0SF1.1	• With escape release from the front	--	24 DC	⊙ B	3SE5 312-0SF11	1	1 unit 41K
		--	115 AC	⊙ B	3SE5 312-0SF12	1	1 unit 41K
		--	230 AC	⊙ B	3SE5 312-0SF13	1	1 unit 41K
	Yellow/Green	--	24 DC	⊙ B	3SE5 312-1SF11	1	1 unit 41K
		--	115 AC	⊙ B	3SE5 312-2SF12	1	1 unit 41K
		--	230 AC	⊙ B	3SE5 312-3SF13	1	1 unit 41K
 3SE5 312-0SG1.1	• With escape release from the back and auxiliary release from the front	--	24 DC	⊙ B	3SE5 312-0SG11	1	1 unit 41K
		--	115 AC	⊙ B	3SE5 312-0SG12	1	1 unit 41K
		--	230 AC	⊙ B	3SE5 312-0SG13	1	1 unit 41K
	Yellow/Green	--	24 DC	⊙ B	3SE5 312-1SG11	1	1 unit 41K
		--	115 AC	⊙ B	3SE5 312-2SG12	1	1 unit 41K
		--	230 AC	⊙ B	3SE5 312-3SG13	1	1 unit 41K
 3SE5 312-0SJ1.1	• With escape release from the back and auxiliary release with lock from the front	--	24 DC	⊙ B	3SE5 312-0SH11	1	1 unit 41K
		--	115 AC	⊙ B	3SE5 312-0SJ11	1	1 unit 41K
		--	230 AC	⊙ B	3SE5 312-0SJ12	1	1 unit 41K
	Yellow/Green	--	24 DC	⊙ B	3SE5 312-1SJ11	1	1 unit 41K
		--	115 AC	⊙ B	3SE5 312-2SJ12	1	1 unit 41K
		--	230 AC	⊙ B	3SE5 312-3SJ13	1	1 unit 41K
 3SE5 312-0SB1.1	Solenoid locks	--	24 DC	⊙ ▶	3SE5 312-0SB11	1	1 unit 41K
		--	115 AC	⊙ B	3SE5 312-0SB12	1	1 unit 41K
		--	230 AC	⊙ B	3SE5 312-0SB13	1	1 unit 41K
	Yellow/Green	--	24 DC	⊙ B	3SE5 312-1SB11	1	1 unit 41K
		--	115 AC	⊙ B	3SE5 312-2SB12	1	1 unit 41K
		--	230 AC	⊙ B	3SE5 312-3SB13	1	1 unit 41K

For online configurator see www.siemens.com/sirius/configurators.

⊙ Positive opening according to IEC 60947-5-1, Appendix K.











¹⁾ Supplied without actuator. Please order separately (see page 12/71).

SIRIUS 3SE5, 3SE2 Mechanical Safety Switches

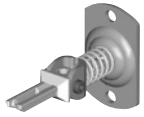
With Solenoid Interlocking

Accessories

Selection and ordering data

Version	DT	Order No.	Price per PU	PU (UNIT, SET, M)	PS*	PG
Actuators for 3SE53						
 3SE5 000-0AV01		Standard actuators, length 75.6 mm	▶	3SE5 000-0AV01	1	1 unit 41K
 3SE5 000-0AV02	A	With vertical fixing, length 53 mm		3SE5 000-0AV02	1	1 unit 41K
 3SE5 000-0AV03	A	With transverse fixing, length 47 mm		3SE5 000-0AV03	1	1 unit 41K
 3SE5 000-0AV04	A	Radius actuators, length 51 mm		3SE5 000-0AV04	1	1 unit 41K
	A	<ul style="list-style-type: none"> Direction of approach from the left Direction of approach from the right 		3SE5 000-0AV06	1	1 unit 41K
 3SE5 000-0AV05-1AA6	A	Universal radius actuators		3SE5 000-0AV05	1	1 unit 41K
	A	<ul style="list-style-type: none"> Length 77 mm Length 77 mm, tab rotated 90° 		3SE5 000-0AV05-1AA6	1	1 unit 41K
 3SE5 000-0AV07	A	Universal radius actuators, heavy-duty		3SE5 000-0AV07-1AK2	1	1 unit 41K
	A	<ul style="list-style-type: none"> Length 67 mm Length 77 mm 		3SE5 000-0AV07	1	1 unit 41K
Optional accessories for 3SE5						
 3SE5 000-0AV08-1AA2	B	Protective caps made of black rubber for the actuator head, to protect the actuator openings from contamination		3SE5 000-0AV08-1AA2	1	1 unit 41K
 3SE5 000-0AV08-1AA3	C	Blocking inserts , high-grade steel, for actuator head, for up to 8 padlocks		3SE5 000-0AV08-1AA3	1	1 unit 41K
Spare parts for 3SE53						
	B	Spare keys		3SX5 100-1F	1	1 unit 41K
Connection for 3SE5						
 3SY3 127	B	Connector sockets (4-pole), M12, fixed for M20 x 1.5 For max. 250 V, 4 A With 0,25 mm ² connecting cable, plastic, degree of protection IP67, ambient temperature -40 to +85 °C		3SY3 127	1	1 unit 41K
	B	Connector sockets (5-pole), M12, fixed for M20 x 1.5 For max. 125 V, 4 A With 0,25 mm ² connecting cable, plastic, degree of protection IP67, ambient temperature -40 to +85 °C		3SY3 128	1	1 unit 41K
 3SX9 926	A	Cable glands M20 x 1.5 Plastic		3SX9 926	1	1 unit 41K

SIRIUS 3SE5, 3SE2 Mechanical Safety Switches

Hinge Switches

General data

Overview

3SE5 hinge switches have the same enclosures as the standard switches (modular system).



Hinge switches

Design

Enclosure sizes

The 3SE5 switches are available as complete units in two enclosure sizes:

- Plastic enclosures according to EN 50047, 31 mm wide, IP65, 1 cable entry
- Metal enclosures according to EN 50047, 31 mm wide, IP66/IP67, 1 cable entry
- Plastic and metal enclosures according to EN 50041, 40 mm wide, IP66/IP67, 1 cable entry

Enclosure versions

Various basic versions can be selected for the enclosures:

- Available with two or three-pole contact blocks designed as snap-action contacts
- Metal enclosures for explosion protection (ATEX) (see page 12/85)
- AS-Interface version with integrated ASIsafe electronics for all enclosure designs (see page 12/101)

For a description of the basic switches, see page 12/4.

Operating mechanism

The hinge switches are provided for mounting on hinges. The actuator head is included in the scope of supply. There are two versions:

- Operating mechanism with hollow shaft, inner diameter 8 mm, outer 12 mm
- Operating mechanism with solid shaft, diameter 10 mm

Benefits

The 3SE5 hinge switches differ from the previous series through the following new characteristics:

- All actuators can be turned around the axis in increments of 22.5° (see picture on page 12/5).
- The new three-pole contact block 1 NO + 2 NC is available for all enclosure sizes (see picture on page 12/5).
- The plastic enclosure with a width of 31 mm has simple and fast wiring equipment which makes it possible to save from approx. 20 to 25 % of the time when connecting (see picture on page 12/5).
- The ASIsafe electric component is integrated for the versions with the AS-Interface connection (see page 12/86); an additional adapter is not required.

Application

The hinge switches are used in those areas where the position of swiveling protective devices such as doors or flaps must be monitored. With these switches, the position of the doors and hinge switches is converted into electric signals. The switches allow shutdown and signaling without delay in the event of a small opening angle through the snap-action contacts with an operating angle of 10°.

Devices are available with enclosure versions to suit the particular ambient conditions. Different control tasks can be performed with the best contact blocks suited for the particular purpose. Dimensions and fixing points of the enclosures are in accordance with EN 50041 or EN 50047 standards.

The devices are suitable for use in any climate.

Standards

IEC 60947-5-1 or EN 60947-5-1.

The protective measure of "total insulation" by the molded-plastic enclosure is guaranteed by the use of molded-plastic screw-glands.

Safety position switches

For controls according to IEC 60204-1 or EN 60204-1 the devices can be used as a safety position switch. To secure position switches against changes in their position, keyed techniques must be employed on installation.

Safety circuits

IEC 60947-5-1 and EN 60947-5-1 require positive opening of the NC contacts, i.e. for the purposes of personal safety, the assured opening of NC contacts is expressly stipulated for the electrical equipment of machines in all safety circuits and marked according to IEC 60947-5-1 with the symbol ☞.

Category 4 according to EN 954-1 can be attained with the 3SE5 hinge switches with ☞ if the corresponding failsafe evaluation units are selected and correctly installed, e.g. the 3TK28 safety relays or matching devices from the ASIsafe, SIMATIC or SINUMERIK product ranges.

SIRIUS 3SE5, 3SE2 Mechanical Safety Switches Hinge Switches

General data

Technical specifications

The technical specifications are the same as for the standard switches (see page 12/7).

Configuration

Enclosure width 31 mm

With hollow shaft
3SE5 212-0.U21, 3SE5 232-0.U21

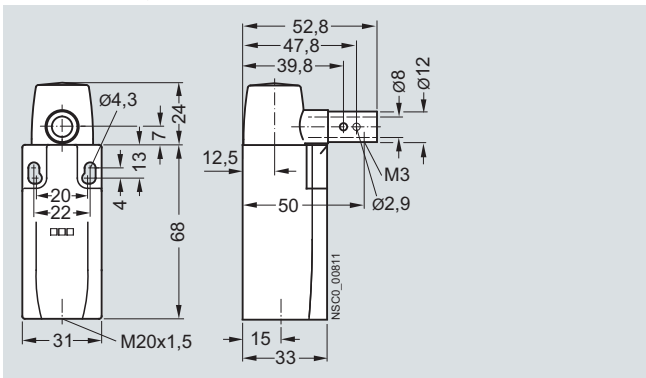

With solid shaft
3SE5 212-0.U22, 3SE5 232-0.U22

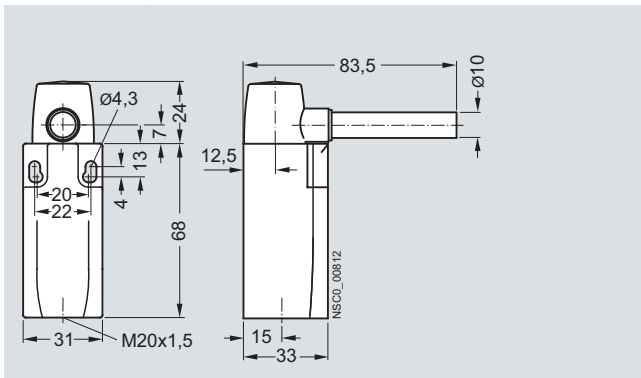

Enclosure width 40 mm

With hollow shaft
3SE5 112-0.U21, 3SE5 132-0.U21

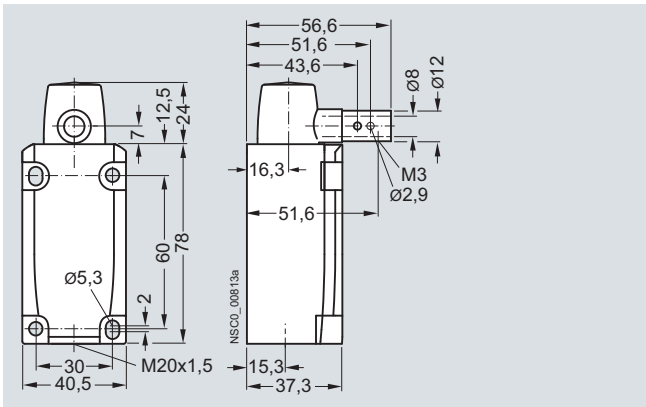

With solid shaft
3SE5 112-0.U22, 3SE5 132-0.U22

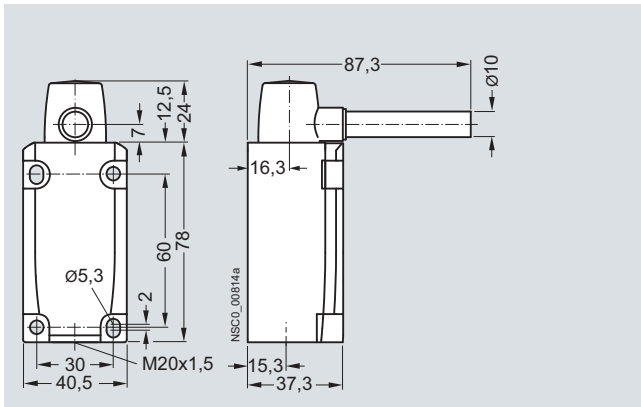

Operating travel of the shaft

Snap-action contacts

1 NO + 1 NC, Ident. No. 11

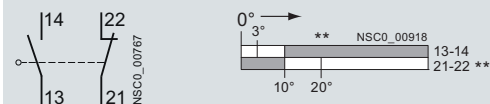

1 NO + 2 NC, Ident. No. 12

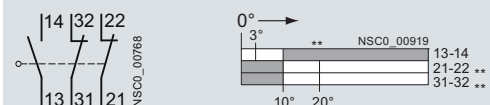

■ Contact closed
□ Contact open
** Positive opening point

SIRIUS 3SE5, 3SE2 Mechanical Safety Switches

Hinge Switches

3SE5, plastic enclosures
Enclosure width 31 mm / 40 mm

Selection and ordering data

Complete units

2 or 3 contacts · Degree of protection IP65 (31 mm) or IP67/IP68 (40 mm) · Cable entry M20 × 1.5

Version	Snap-action contacts	DT	Complete units	PU (UNIT, SET, M)	PS*	PG
			<input type="checkbox"/>			
						
			Order No.	Price per PU		

Plastic enclosures · Enclosure width 31 mm acc. to EN 50047



With hollow shaft

With hollow shaft

Operating angle 10°

1 NO + 1 NC ⤴ B

3SE5 232-0HU21

1 1 unit 41K

Operating angle 10°

1 NO + 2 NC ⤴ B

3SE5 232-0LU21

1 1 unit 41K



With solid shaft

With solid shaft

Operating angle 10°

1 NO + 1 NC ⤴ B

3SE5 232-0HU22

1 1 unit 41K

Operating angle 10°

1 NO + 2 NC ⤴ B

3SE5 232-0LU22

1 1 unit 41K

Plastic enclosures · Enclosure width 40 mm acc. to EN 50041



With hollow shaft

With hollow shaft

Operating angle 10°

1 NO + 2 NC ⤴ B

3SE5 132-0LU21

1 1 unit 41K



With solid shaft

With solid shaft

Operating angle 10°

1 NO + 2 NC ⤴ B

3SE5 132-0LU22

1 1 unit 41K

 For online configurator see www.siemens.com/sirius/configurators.

 Positive opening according to IEC 60947-5-1, Appendix K.

Spare parts

Version	DT	Order No.	Price per PU	PU (UNIT, SET, M)	PS*	PG
---------	----	-----------	--------------	-------------------	-----	----

Actuator heads



With hollow shaft

With hollow shaft

Operating angle 10°

B

3SE5 000-0AU21

1 1 unit 41K



With solid shaft

With solid shaft

Operating angle 10°

B

3SE5 000-0AU22

1 1 unit 41K

Note:

The respective actuators are included in the scope of supply for the complete units.

SIRIUS 3SE5, 3SE2 Mechanical Safety Switches

Hinge Switches

**3SE5, metal enclosures
Enclosure width 31 mm / 40 mm**



Selection and ordering data

Complete units



3 contacts · Degree of protection IP66/IP67 · Cable entry M20 × 1.5

Version	Snap-action contacts	DT	Complete units	PU (UNIT, SET, M)	PS*	PG
			<input type="checkbox"/>			
			Order No.	Price per PU		

Metal enclosures · Enclosure width 31 mm acc. to EN 50047

	With hollow shaft Operating angle 10°	1 NO + 2 NC	⊕ B	3SE5 212-0LU21	1	1 unit	41K
	With solid shaft Operating angle 10°	1 NO + 2 NC	⊕ B				
	With hollow shaft Operating angle 10°	1 NO + 2 NC	⊕ B	3SE5 212-0LU22	1	1 unit	41K
	With solid shaft Operating angle 10°	1 NO + 2 NC	⊕ B				

Metal enclosures · Enclosure width 40 mm acc. to EN 50041

	With hollow shaft Operating angle 10°	1 NO + 2 NC	⊕ B	3SE5 112-0LU21	1	1 unit	41K
	With solid shaft Operating angle 10°	1 NO + 2 NC	⊕ B				
	With hollow shaft Operating angle 10°	1 NO + 2 NC	⊕ B	3SE5 112-0LU22	1	1 unit	41K
	With solid shaft Operating angle 10°	1 NO + 2 NC	⊕ B				



For online configurator see www.siemens.com/sirius/configurators.

⊕ Positive opening according to IEC 60947-5-1, Appendix K.

Spare parts

Version	DT	Order No.	Price per PU	PU (UNIT, SET, M)	PS*	PG
---------	----	-----------	--------------	-------------------	-----	----

Actuator heads

	With hollow shaft Operating angle 10°	B	3SE5 000-0AU21	1	1 unit	41K
	With solid shaft Operating angle 10°	B				
	With hollow shaft Operating angle 10°	B	3SE5 000-0AU22	1	1 unit	41K
	With solid shaft Operating angle 10°	B				

Note:

The respective actuators are included in the scope of supply for the complete units.

SIRIUS 3SE5, 3SE2 Mechanical Safety Switches

Hinge Switches

3SE2, plastic enclosures With integrated hinge

Overview

The 3SE2 283 hinge switches are particularly suitable for use in doors and hinge switches of machines that must be closed to ensure the safety of operating personnel. Their thin profile and compact design allow them to be directly mounted on a hinged protective cover and the stable frame.

Benefits

- Easy mounting through use of versions with integrated hinge
- Versions with small operating angle of 4°
- Protection against personal injury provided by positively driven NC contacts according to IEC 60947-5-1
- Simultaneous shutdown and reporting by 1 NO + 2 NC contacts

Technical specifications

Type	3SE2 283	
Rated insulation voltage U_i	V	250
Conventional thermal current I_{th}	A	2.5
Rated operational current I_e		
• At AC-15, 120 V	A	4.2
• At AC-15, 250 V	A	2
• At DC-13, 24 V	A	1
Min. make-break capacity	>5 V / 1 mA	
Short-circuit protection		
• gG operational class	A	2
Mechanical endurance	> 1 × 10 ⁶ operating cycles	
Switching frequency	1200 operating cycles/hour	
Positive opening	2 mm after opening point	
Enclosure material	Plastic	
Degree of protection	IP65	
Ambient temperature	°C	-25 ... +65
Shock resistance	30 g/18 ms	
Resistance to vibrations	20 g/10 ... 200 Hz	
Cable entry	2 × (M20 × 1.5)	
Screw terminals	0.5 ... 1.5 mm ² /AWG 15	

Configuration

3SE2 283-GA.3 hinge switch with hinge

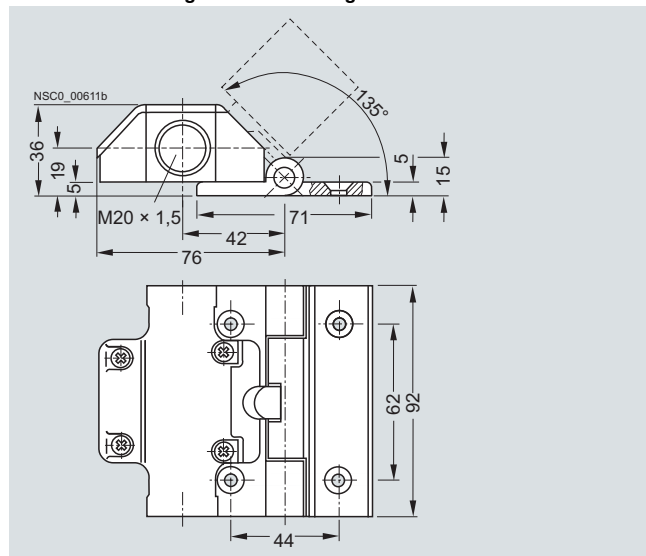

3SX3 225 additional hinge

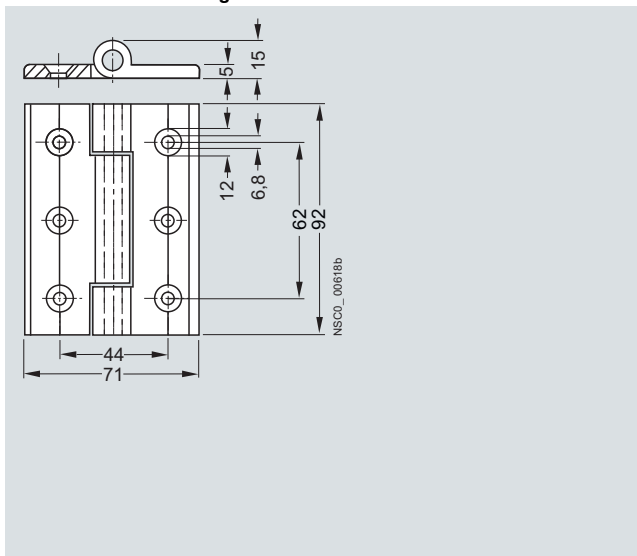

Operating travel of the hinge

Slow-action contacts

1 NO + 2 NC, Ident. No. 12

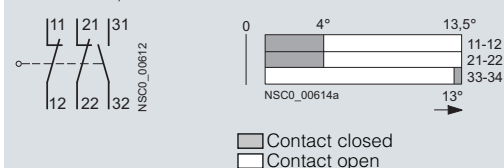

Slow-action contacts

3 NC, Ident. No. 03

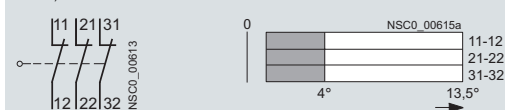

SIRIUS 3SE5, 3SE2 Mechanical Safety Switches

Hinge Switches

3SE2, plastic enclosures
With integrated hinge

Selection and ordering data

3 contacts · Degree of protection IP65 · Cable entry 2 × (M20 × 1.5)

Version	Slow-action contacts	DT	Complete units	PU (UNIT, SET, M)	PS*	PG
			<input type="checkbox"/>			
			Order No.	Price per PU		

Plastic enclosures with integrated hinge



3SE2 283

With integrated hinge

(Delivery includes additional hinge and fixing accessories)

• Aluminum hinge

- Operating angle 4°	1 NO + 2 NC	⊕ A	3SE2 283-0GA43	1	1 unit	41K
- Operating angle 4°	3 NC	⊕ B	3SE2 283-6GA43	1	1 unit	41K
- Operating angle 8°	1 NO + 2 NC	⊕ C	3SE2 283-0GA53	1	1 unit	41K
- Operating angle 8°	3 NC	⊕ C	3SE2 283-6GA53	1	1 unit	41K

• High-grade steel hinge

- Operating angle 4°	1 NO + 2 NC	⊕ B	3SE2 283-0GA44	1	1 unit	41K
- Operating angle 4°	3 NC	⊕ C	3SE2 283-6GA44	1	1 unit	41K

⊕ Positive opening according to IEC 60947-5-1, Appendix K.

Accessories/spare parts

Version	DT	Order No.	Price per PU	PU (UNIT, SET, M)	PS*	PG

Accessories



3SX3 225

Additional hinges

(delivered with fixing accessories)

- Made of aluminum
- Made of high-grade steel

⊕ D	D	3SX3 225		1	1 unit	41K
⊕ D	D	3SX3 231		1	1 unit	41K

⊕ Positively driven actuator

SIRIUS 3SE5 Mechanical Position Switches for Explosion Protection

General data

Overview



Position switches and safety switches acc. to ATEX with grounding screw

Position switches in a metal enclosure including the safety switches with a separate actuator and the safety hinge switches are also available in versions for operation in areas with combustible dust.

These switches are not suitable for operation in areas with gas explosion hazard. An exception is the type of protection intrinsic safety i: Use as "simple electrical equipment" is possible (see Certificate No. 2849).

To achieve the maximum possible safety in these areas, the legislators of most countries have drawn up requirements in the form of laws, regulations and standards which these switches comply with to the letter.

These switches comply with Directive 94/9/EC II2D (ATEX 95) of the European Union and are approved for Zone 21/22.

See www.siemens.com/sirius/atex.

They have a grounding screw on the outside of the enclosure but are otherwise identical with the standard enclosures. The connection openings are closed with protective caps upon delivery.



SIRIUS 3SE5 Mechanical Position Switches for Explosion Protection

3SE5, metal enclosures
Enclosure width 31 mm acc. to EN 50047

Selection and ordering data

Modular system

2 or 3 contacts · Degree of protection IP66/IP67 · Cable entry M20 × 1.5







Version	Contacts	DT	Modular system	PU (UNIT, SET, M)	PS*	PG
						
			Configurator			
			Order No.	Price per PU		

Basic switches · Enclosure width 31 mm acc. to EN 50047 (with rounded plunger¹⁾)



Rounded plunger

With M20 × 1.5 connecting thread

Slow-action contacts	1 NO + 1 NC		B	3SE5 212-0BC05-1DA0	1	1 unit	41K
Snap-action contacts	1 NO + 1 NC		B	3SE5 212-0CC05-1DA0	1	1 unit	41K
Slow-action contacts	1 NO + 2 NC		B	3SE5 212-0KC05-1DA0	1	1 unit	41K
Snap-action contacts	1 NO + 2 NC		B	3SE5 212-0LC05-1DA0	1	1 unit	41K
Slow-action contacts with make-before-break	1 NO + 2 NC		B	3SE5 212-0MC05-1DA0	1	1 unit	41K
Slow-action contacts	2 NO + 1 NC		B	3SE5 212-0PC05-1DA0	1	1 unit	41K

 For online configurator see www.siemens.com/sirius/configurators.

 Positively opening according to IEC 60947-5-1, Appendix K, or positively driven actuator, necessary in safety circuits.

¹⁾ On enclosure width 31 mm the basic switch is a complete unit with rounded plunger.

Note:

Selection aid see page 12/12.

Version	Diameter	DT	Modular system	PU (UNIT, SET, M)	PS*	PG
						
	mm		Order No.	Price per PU		

Operating mechanisms



Plain plunger

Plain plungers

High-grade steel plungers	10		A	3SE5 000-0AB01	1	1 unit	41K
---------------------------	----	---	---	-----------------------	---	--------	-----



Roller plunger

Roller plungers, type C acc. to EN 50047

Plastic rollers	10		A	3SE5 000-0AD03	1	1 unit	41K
High-grade steel rollers	10		B	3SE5 000-0AD04	1	1 unit	41K



With central fixing









Roller plungers with central fixing

Plastic rollers	10		B	3SE5 000-0AD10	1	1 unit	41K
High-grade steel rollers	10		B	3SE5 000-0AD11	1	1 unit	41K

 Positively driven actuator

SIRIUS 3SE5 Mechanical Position Switches for Explosion Protection

3SE5, metal enclosures Enclosure width 31 mm acc. to EN 50047

Version	Diameter	DT	Modular system	PU (UNIT, SET, M)	PS*	PG
	mm		Order No.	Price per PU		
Operating mechanisms						
	Roller levers, type E acc. to EN 50047					
	Metal lever, plastic roller	13	⊕ A	3SE5 000-0AE10	1	1 unit 41K
	Metal lever, high-grade steel roller	13	⊕ B	3SE5 000-0AE11	1	1 unit 41K
	High-grade steel lever, plastic roller	13	⊕ B	3SE5 000-0AE12	1	1 unit 41K
	Angular roller levers					
	Metal lever, plastic roller	13	⊕ A	3SE5 000-0AF10	1	1 unit 41K
	Metal lever, high-grade steel roller	13	⊕ B	3SE5 000-0AF11	1	1 unit 41K
	High-grade steel lever, plastic roller	13	⊕ A	3SE5 000-0AF12	1	1 unit 41K
	Spring rod (for switches with snap-action contacts only)					
	Plastic plunger and high-grade steel spring:					
	• Length 142.5 mm (spring 50 mm, plunger 50 mm)		B	3SE5 000-0AR01	1	1 unit 41K
	• Length 76 mm (spring 23.5 mm, plunger 10 mm)		B	3SE5 000-0AR03	1	1 unit 41K
High-grade steel plunger and spring:						
• Length 242.5 mm (spring 150 mm, plunger 50 mm)		B	3SE5 000-0AR04	1	1 unit 41K	
• Length 142.5 mm (spring 50 mm, plunger 50 mm)		B	3SE5 000-0AR02	1	1 unit 41K	
Twist actuators						
	Twist actuators, plastic (without lever)					
	Switching right and/or left, adjustable		⊕ A	3SE5 000-0AK00	1	1 unit 41K
	Lever for twist actuators					
	Twist levers, straight, type A acc. to EN 50047					
	Metal lever 21 mm, plastic roller	19	⊕ A	3SE5 000-0AA21	1	1 unit 41K
	Metal lever 21 mm, high-grade steel roller	19	⊕ B	3SE5 000-0AA22	1	1 unit 41K
	Metal lever 21 mm, roller with ball bearing	19	⊕ B	3SE5 000-0AA23	1	1 unit 41K
	Metal lever 21 mm, plastic roller	30	⊕ B	3SE5 000-0AA25	1	1 unit 41K
	High-grade steel lever 21 mm, plastic roller	19	⊕ B	3SE5 000-0AA31	1	1 unit 41K
	High-grade steel lever 21 mm, high-grade steel roller	19	⊕ B	3SE5 000-0AA32	1	1 unit 41K
	Twist levers 30 mm, straight¹⁾					
	Metal lever, plastic roller	19	⊕ B	3SE5 000-0AA24	1	1 unit 41K
	Twist levers, adjustable length, with grid hole					
	Metal lever, plastic roller	19	⊕ B	3SE5 000-0AA60	1	1 unit 41K
	Metal lever, high-grade steel roller	19	⊕ B	3SE5 000-0AA61	1	1 unit 41K
	Metal lever, plastic roller	50	⊕ B	3SE5 000-0AA67	1	1 unit 41K
	Metal lever, rubber roller	50	⊕ B	3SE5 000-0AA68	1	1 unit 41K
	High-grade steel lever, plastic roller	19	⊕ B	3SE5 000-0AA62	1	1 unit 41K
	High-grade steel lever, high-grade steel roller	19	⊕ B	3SE5 000-0AA63	1	1 unit 41K
	Twist levers, adjustable length					
	Metal lever, plastic roller	19	A	3SE5 000-0AA50	1	1 unit 41K
	Metal lever, high-grade steel roller	19	B	3SE5 000-0AA51	1	1 unit 41K
	Metal lever, plastic roller	30	B	3SE5 000-0AA55	1	1 unit 41K
	Metal lever, plastic roller	50	B	3SE5 000-0AA57	1	1 unit 41K
	Metal lever, rubber roller	50	B	3SE5 000-0AA58	1	1 unit 41K
	High-grade steel lever, plastic roller	19	B	3SE5 000-0AA52	1	1 unit 41K
	High-grade steel lever, high-grade steel roller	19	B	3SE5 000-0AA53	1	1 unit 41K
	Rod actuators, type D acc. to EN 50041					
	Aluminum rod, length 200 mm	6	B	3SE5 000-0AA80	1	1 unit 41K
	Spring rod, length 200 mm	6	B	3SE5 000-0AA81	1	1 unit 41K
	Plastic rod, length 200 mm	6	B	3SE5 000-0AA82	1	1 unit 41K
	Plastic rod, length 330 mm	6	B	3SE5 000-0AA83	1	1 unit 41K

⊕ Positively driven actuator, necessary in safety circuits.

¹⁾ Can be clinch mounted (turned through 180°, rear of lever).





SIRIUS 3SE5 Mechanical Position Switches for Explosion Protection

3SE5, metal enclosures
Enclosure width 40 mm acc. to EN 50041 / 56 mm

Selection and ordering data

Complete units

2 contacts · Degree of protection IP66/IP67 · Cable entry M20 × 1.5

Version	Snap-action contacts	DT	Complete units	<input type="checkbox"/>	PU (UNIT, SET, M)	PS*	PG
			Configurator				
			Order No.	Price per PU			
Enclosure width 40 mm acc. to EN 50041							
	With M20 × 1.5 connecting thread Snap-action contacts	1 NO + 1 NC					
Rounded plunger	<ul style="list-style-type: none"> • Rounded plungers, high-grade steel, with 3 mm overtravel • Roller plungers, high-grade steel roller, with 3 mm overtravel • Roller lever, high-grade steel lever, plastic roller • Angular roller lever, high-grade steel lever, plastic roller • Spring rod, length 142.5 mm Plastic plunger • Twist lever, high-grade steel lever, plastic roller • Twist lever, adjustable length High-grade steel lever, plastic roller • Fork lever, high-grade steel lever, plastic roller • Rod actuators, aluminum rod, length 200 mm • Rod actuators, plastic rod, length 200 mm 		⊕ B	3SE5 112-0CC02-1DA0	1	1 unit	41K
			⊕ B	3SE5 112-0CD02-1DA0	1	1 unit	41K
			⊕ B	3SE5 112-0CE03-1DA0	1	1 unit	41K
			⊕ B	3SE5 112-0CF03-1DA0	1	1 unit	41K
			B	3SE5 112-0CR01-1DA0	1	1 unit	41K
Roller lever			⊕ B	3SE5 112-0CH11-1DA0	1	1 unit	41K
			B	3SE5 112-0CH52-1DA0	1	1 unit	41K
			⊕ B	3SE5 112-0CT13-1DA0	1	1 unit	41K
			B	3SE5 112-0CH80-1DA0	1	1 unit	41K
			B	3SE5 112-0CH82-1DA0	1	1 unit	41K
Enclosure width 56 mm							
	With 3 x M20 x 1.5 connecting thread Snap-action contacts	1 NO + 1 NC					
Roller plunger	<ul style="list-style-type: none"> • Rounded plunger, high-grade steel, with overtravel • Roller plunger, high-grade steel roller • Roller lever, high-grade steel lever, plastic roller • Angular roller lever, high-grade steel lever, plastic roller • Spring rod, length 142.5 mm Plastic plunger • Twist lever, high-grade steel lever, plastic roller 		⊕ B	3SE5 122-0CC02-1DA0	1	1 unit	41K
			⊕ B	3SE5 122-0CD02-1DA0	1	1 unit	41K
			⊕ B	3SE5 122-0CE03-1DA0	1	1 unit	41K
			⊕ B	3SE5 122-0CF03-1DA0	1	1 unit	41K
			B	3SE5 122-0CR01-1DA0	1	1 unit	41K
Twist lever			⊕ B	3SE5 122-0CH11-1DA0	1	1 unit	41K

For online configurator see www.siemens.com/sirius/configurators.

Positive opening according to IEC 60947-5-1, Appendix K

Note:

If the device you require is not available as a complete unit, see "Modular System", page 12/82.

SIRIUS 3SE5 Mechanical Position Switches for Explosion Protection

3SE5, metal enclosures Enclosure width 40 mm acc. to EN 50041 / 56 mm

Modular system

2 or 3 contacts · Degree of protection IP66/IP67 · Cable entry M20 × 1.5

Version	Contacts	DT	Modular system	PU (UNIT, SET, M)	PS*	PG
			Configurator			
			Order No.	Price per PU		

Basic switches • Enclosure width 40 mm acc. to EN 50041

With M20 × 1.5 connecting thread						
 Basic switch	Slow-action contacts	1 NO + 1 NC	⊕ B	3SE5 112-0BA00-1DA0	1	1 unit 41K
	Snap-action contacts	1 NO + 1 NC	⊕ B	3SE5 112-0CA00-1DA0	1	1 unit 41K
	Slow-action contacts	1 NO + 2 NC	⊕ B	3SE5 112-0KA00-1DA0	1	1 unit 41K
	Snap-action contacts	1 NO + 2 NC	⊕ B	3SE5 112-0LA00-1DA0	1	1 unit 41K
	Slow-action contacts with make-before-break	1 NO + 2 NC	⊕ B	3SE5 112-0MA00-1DA0	1	1 unit 41K
	Slow-action contacts	2 NO + 1 NC	⊕ B	3SE5 112-0PA00-1DA0	1	1 unit 41K

Basic switches • Enclosure width 56 mm

With 3 x M20 x 1.5 connecting thread						
 Basic switch	Slow-action contacts	1 NO + 1 NC	⊕ B	3SE5 122-0BA00-1DA0	1	1 unit 41K
	Snap-action contacts	1 NO + 1 NC	⊕ B	3SE5 122-0CA00-1DA0	1	1 unit 41K
	Slow-action contacts	1 NO + 2 NC	⊕ B	3SE5 122-0KA00-1DA0	1	1 unit 41K
	Snap-action contacts	1 NO + 2 NC	⊕ B	3SE5 122-0LA00-1DA0	1	1 unit 41K
	Slow-action contacts with make-before-break	1 NO + 2 NC	⊕ B	3SE5 122-0MA00-1DA0	1	1 unit 41K
	Slow-action contacts	2 NO + 1 NC	⊕ B	3SE5 122-0PA00-1DA0	1	1 unit 41K

Basic switches • Enclosure width 56 mm, XL

With 3 x M20 x 1.5 connecting thread						
 Basic switch	Slow-action contacts	2 × (1 NO + 1 NC)	⊕ B	3SE5 162-0BA00-1DA0	1	1 unit 41K
	Snap-action contacts	2 × (1 NO + 1 NC)	⊕ B	3SE5 162-0CA00-1DA0	1	1 unit 41K
	Slow-action contacts with make-before-break	2 × (1 NO + 2 NC)	⊕ B	3SE5 162-0DA00-1DA0	1	1 unit 41K

For online configurator see www.siemens.com/sirius/configurators.





⊕ Positive opening according to IEC 60947-5-1, Appendix K, or positively driven actuator, necessary in safety circuits.

Note:

Selection aid see page 12/12.

Version	Diameter	DT	Modular system	PU (UNIT, SET, M)	PS*	PG
	mm		Order No.	Price per PU		







Operating mechanisms

 Rounded plunger	Plain plungers					
	High-grade steel plunger		⊕ A	3SE5 000-0AB01	1	1 unit 41K
 Roller plunger	Rounded plungers, type B, acc. to EN 50041					
	High-grade steel plunger, with 3 mm overtravel		⊕ B	3SE5 000-0AC02	1	1 unit 41K
 Roller lever	Roller plungers, type C acc. to EN 50041					
	High-grade steel roller, with 3 mm overtravel	13	⊕ B	3SE5 000-0AD02	1	1 unit 41K
 Angular roller lever	Roller levers					
	Metal lever, plastic roller	22	⊕ A	3SE5 000-0AE01	1	1 unit 41K
	Metal lever, high-grade steel roller	22	⊕ B	3SE5 000-0AE02	1	1 unit 41K
	High-grade steel lever, plastic roller	22	⊕ B	3SE5 000-0AE03	1	1 unit 41K
 Angular roller lever	Angular roller levers					
	High-grade steel lever, high-grade steel roller	22	⊕ B	3SE5 000-0AE04	1	1 unit 41K
	Metal lever, plastic roller	22	⊕ A	3SE5 000-0AF01	1	1 unit 41K
	Metal lever, high-grade steel roller	22	⊕ B	3SE5 000-0AF02	1	1 unit 41K
	High-grade steel lever, plastic roller	22	⊕ B	3SE5 000-0AF03	1	1 unit 41K
	High-grade steel lever, high-grade steel roller	22	⊕ B	3SE5 000-0AF04	1	1 unit 41K

⊕ Positively driven actuator, necessary in safety circuits.

SIRIUS 3SE5 Mechanical Position Switches for Explosion Protection

3SE5, metal enclosures
Enclosure width 40 mm acc. to EN 50041 / 56 mm

Version	Diameter	DT	Modular system	PU (UNIT, SET, M)	PS*	PG		
	mm		Order No.	Price per PU				
Operating mechanisms								
	Spring rods (for switches with snap-action contacts only) Plastic plunger and high-grade steel spring:							
	• Length 142.5 mm (spring 50 mm, plunger 50 mm)	B	3SE5 000-0AR01	1	1 unit	41K		
	• Length 76 mm (spring 23.5 mm, plunger 10 mm)	B	3SE5 000-0AR03	1	1 unit	41K		
	• Length 242.5 mm (spring 150 mm, plunger 50 mm)	B	3SE5 000-0AR04	1	1 unit	41K		
Spring rod	High-grade steel plunger and spring:							
	• Length 142.5 mm (spring 50 mm, plunger 50 mm)	B	3SE5 000-0AR02	1	1 unit	41K		
Twist actuators								
	Twist actuators , metal (without lever)							
	• For twist levers and rod actuators, switching right and/or left, adjustable - For enclosure width 40 and 56 mm		⊕ A	3SE5 000-0AH00	1	1 unit	41K	
	• For fork levers, latching		⊕ B	3SE5 000-0AT10	1	1 unit	41K	
Levers for twist actuators								
	Twist levers 27 mm, offset, type A, acc. to EN 50041							
	Metal lever, plastic roller	19	⊕ A	3SE5 000-0AA01	1	1 unit	41K	
	Metal lever, high-grade steel roller	19	⊕ A	3SE5 000-0AA02	1	1 unit	41K	
	Metal lever, roller with ball bearing	19	⊕ B	3SE5 000-0AA03	1	1 unit	41K	
	Metal lever, 2 plastic rollers	19	⊕ B	3SE5 000-0AA04	1	1 unit	41K	
	Metal lever, plastic roller	30	⊕ B	3SE5 000-0AA05	1	1 unit	41K	
	Metal lever, rubber roller	50	⊕ B	3SE5 000-0AA08	1	1 unit	41K	
	High-grade steel lever, plastic roller	19	⊕ B	3SE5 000-0AA11	1	1 unit	41K	
	High-grade steel lever, high-grade steel roller	19	⊕ B	3SE5 000-0AA12	1	1 unit	41K	
		Twist levers 35 mm, offset						
		Metal lever, plastic roller	19	⊕ B	3SE5 000-0AA15	1	1 unit	41K
		Twist levers 30 mm, straight¹⁾						
	Metal lever, plastic roller	19	⊕ B	3SE5 000-0AA24	1	1 unit	41K	
	Metal lever, plastic roller	30	⊕ B	3SE5 000-0AA26	1	1 unit	41K	
	Twist levers, adjustable length, with grid hole							
	Metal lever, plastic roller	19	⊕ B	3SE5 000-0AA60	1	1 unit	41K	
	Metal lever, high-grade steel roller	19	⊕ B	3SE5 000-0AA61	1	1 unit	41K	
	Metal lever, rubber roller	50	⊕ B	3SE5 000-0AA68	1	1 unit	41K	
	High-grade steel lever, plastic roller	19	⊕ B	3SE5 000-0AA62	1	1 unit	41K	
	High-grade steel lever, high-grade steel roller	19	⊕ B	3SE5 000-0AA63	1	1 unit	41K	
	Twist levers, adjustable length							
	Metal lever, plastic roller	19	A	3SE5 000-0AA50	1	1 unit	41K	
	Metal lever, high-grade steel roller	19	B	3SE5 000-0AA51	1	1 unit	41K	
	Metal lever, plastic roller	30	B	3SE5 000-0AA55	1	1 unit	41K	
	Metal lever, rubber roller	50	B	3SE5 000-0AA58	1	1 unit	41K	
	High-grade steel lever, plastic roller	19	B	3SE5 000-0AA52	1	1 unit	41K	
	High-grade steel lever, high-grade steel roller	19	B	3SE5 000-0AA53	1	1 unit	41K	
		Fork levers (for switches with snap-action contacts only)						
2 metal levers, 2 plastic rollers		19	⊕ B	3SE5 000-0AT01	1	1 unit	41K	
2 metal levers, 2 high-grade steel rollers		19	⊕ B	3SE5 000-0AT02	1	1 unit	41K	
2 high-grade steel levers, 2 plastic rollers		19	⊕ B	3SE5 000-0AT03	1	1 unit	41K	
2 high-grade steel levers, 2 high-grade steel rollers		19	⊕ B	3SE5 000-0AT04	1	1 unit	41K	
Rod actuator	Rod actuators, type D, acc. to EN 50041							
	Aluminum rod, length 200 mm	6	B	3SE5 000-0AA80	1	1 unit	41K	
	Spring rod, length 200 mm	6	B	3SE5 000-0AA81	1	1 unit	41K	
	Plastic rod, length 200 mm	6	B	3SE5 000-0AA82	1	1 unit	41K	

⊕ Positively driven actuator, necessary in safety circuits.

¹⁾ Can be clinch mounted (turned through 180°, rear of lever).

SIRIUS 3SE5 Mechanical Safety Switches for Explosion Protection



With Separate Actuator

3SE5, metal enclosures
Enclosure width 31 mm / 40 mm / 56 mm

Overview

Complete units

5 directions of approach · 3 contacts · Degree of protection IP66/IP67 · Cable entry M20 × 1.5

Version ¹⁾	Contacts	DT	Complete units	PU (UNIT, SET, M)	PS*	PG
			Configurator			
			Order No.	Price per PU		
Enclosure width 31 mm acc. to EN 50047						
	With M20 × 1.5 connecting thread Slow-action contacts	1 NO + 2 NC	⊕ B	3SE5 212-0QV40-1DA0	1	1 unit 41K
With separate actuator						
Enclosure width 40 mm acc. to EN 50041						
	With M20 × 1.5 connecting thread Slow-action contacts	1 NO + 2 NC	⊕ B	3SE5 112-0QV10-1DA0	1	1 unit 41K
With separate actuator						
Enclosure width 56 mm						
	With 3 x M20 x 1.5 connecting thread Slow-action contacts	1 NO + 2 NC	⊕ B	3SE5 122-0QV10-1DA0	1	1 unit 41K
With separate actuator						

For online configurator see www.siemens.com/sirius/configurators .

⊕ Positive opening according to IEC 60947-5-1, Appendix K.

¹⁾ Supplied without actuator. Please order separately (see page 12/63).

SIRIUS 3SE5 Mechanical Safety Switches for Explosion Protection





Hinge Switches

3SE5, metal enclosures
Enclosure width 31 mm / 40 mm

Overview

Complete units

3 contacts · Degree of protection IP66/IP67 · Cable entry M20 × 1.5

Version	Snap-action contacts	DT	Complete units	Configurator	Order No.	Price per PU	PU (UNIT, SET, M)	PS*	PG
Enclosure width 31 mm acc. to EN 50047									
	With hollow shaft , Ø 8/12 mm Operating angle 10°	1 NO + 2 NC	⊕ B	3SE5 212-0LU21-1DA0			1	1 unit	41K
With hollow shaft									
	With solid shaft , Ø = 10 mm Operating angle 10°	1 NO + 2 NC	⊕ B	3SE5 212-0LU22-1DA0			1	1 unit	41K
With solid shaft									
Enclosure width 40 mm acc. to EN 50041									
	With hollow shaft , Ø 8/12 mm Operating angle 10°	1 NO + 2 NC	⊕ B	3SE5 112-0LU21-1DA0			1	1 unit	41K
With hollow shaft									
	With solid shaft , Ø = 10 mm Operating angle 10°	1 NO + 2 NC	⊕ B	3SE5 112-0LU22-1DA0			1	1 unit	41K
With solid shaft									

⚙ For online configurator see www.siemens.com/sirius/configurators.

⊕ Positive opening according to IEC 60947-5-1, Appendix K, or positive drive for use in safety circuits.

SIRIUS 3SF1 Mechanical Safety Switches for AS-Interface

General data

Overview

The 3SF1 position switches with safety-oriented communication can be directly connected using the AS-Interface bus system. The safety functions no longer have to be conventionally wired up.

With the 3SF1 position switches the ASIsafe electronics are integrated in the switch enclosure.



Examples of selection options in the modular system

Modular system

The position switches of the 3SF1 1.4 and 3SF1 2.4 series are constructed from a modular system comprising different versions of the basic switch and an actuator which must be ordered separately. Thanks to the modular design of the switch the end user can select the right solution for his application from numerous versions and install it himself in a very short time.

Design

The 3SF1 switches are available in four different enclosure sizes:

- Plastic and metal enclosures according to EN 50047, 31 mm wide, with M12 connector socket
- Metal enclosures according to EN 50041, 40 mm wide, with M12 plug
- Plastic enclosures, 50 mm wide, with M12 plug and M12 socket
- Metal enclosures, 56 mm wide, with M12 plug and M12 socket

Display

The switches have a status display with three LEDs:

- LED 1 (yellow): F-IN1
- LED 2 (yellow): F-IN2
- LED 3 (green/red): AS-I/FAULT

Connection

Connection to the AS-Interface is by means of a 4-pole M12 connector socket (plastic version) connected to the yellow AS-Interface bus cable.

The wide enclosures (50 or 56 mm) also have an M12 socket for connecting a second position switch. Category 4 according to EN 954-1 is thus achieved.

Benefits

The new generation of 3SF1 position switches offers:

- ASIsafe Electronics integrated in the enclosure, with low power consumption < 60 mA
- An extensive range of actuators
- Status display with three LEDs

Application

With the standard position switches, mechanical positions of moved machine parts are converted into electrical signals. Through their modular and uniform design and large number of versions, the devices can meet practically all requirements in industry.

Devices are available with enclosure versions to suit the particular ambient conditions. Different control tasks can be performed with the best contact blocks suited for the particular purpose. And many different actuator versions are available to match the mechanical configuration of the moved machined parts. Dimensions, fixing points and characteristics are largely in accordance with the EN 50041 or EN 50047 standards.

The devices are suitable for use in any climate.

Standards

The switches comply with the standards IEC 60947-1 (Low-Voltage Switchgear and Controlgear, General) and IEC 60947-5-1 (Electromechanical Control Circuit Devices).

The mechanical design of the switch corresponds to the requirements of the failsafe principle according to EN 1088.

Approvals

AS-Interface according to EN 50295 and IEC 62026-2.

With a 3SF1 position switch it is possible to achieve category 2 according to ISO 13849-1 (EN 954-1) or SIL 1 according to IEC 61508.

Categories 3 or 4 according to ISO 13849-1 (EN 954-1) or SIL 2 or 3 according to IEC 61508 can be achieved by using a second 3SE5 position switch.

The 3SF1 position switches are approved according to UL 508, UL 50 and UL 746-C.

Technical specifications

Type	3SF1 1.., 3SF1 2..	
General data		
Standards	IEC 60947-5-1, EN 60947-5-1, EN 1088	
According to AS-Interface specification		
• I/O configuration / ID configuration		7/B
• ID1 code/ID2 code (Hex)		F/F
• Power consumption, overall	mA	≤ 60
Inputs		
• Low signal range		Contact open
• High signal range		Contact closed, I_{in} dynamic ($I_{peak} \geq 5$ mA)
Status display	Green/red dual LED	
Rated impulse withstand voltage U_{imp}	kV	0.6
EMC resistance		
• IEC 60000-1-2	kV	4
• IEC 60000-4-3	V/m	10
• IEC 60000-4-4 (A/B)	kV	1 / 2
Mechanical endurance		
• Basic switches		15×10^6 operating cycles
• With separate actuator, 3SF1 ...-..V..		1×10^6 operating cycles
PFH value		
Probability of failure upon request of the safety function, with 1 actuation per hour and $B10 = 5 \times 10^9$		
• Basic switches	1/h	4×10^{-9}
• With separate actuator, 3SF1 ...-..V..	1/h	2×10^{-9}
• Hinge switch, 3SF1 ...-..U..	1/h	2×10^{-9}
Shock resistance acc. to IEC 60068-2-27	30 g/11 ms	

Type	3SF1 234	3SF1 134	3SF1 244	3SF1 214	3SF1 114	3SF1 124
Enclosure						
Enclosure	Ultradim A3X2G7			Zinc diecasting GD Zn Al4 Cu1		
• Material						
• Width	mm	31	40	50	31	40
• Dimensions acc. to EN		EN 50047	EN 50041	--	EN 50047	EN 50041
Degree of protection acc. to IEC 60529		IP65	IP66/IP67 ¹⁾			
Ambient temperature						
• During operation	°C	-25 ... +60				
• Storage, transport	°C	-40 ... +80				
Mounting position	Any					

¹⁾ For twist actuators with spring rod and rod actuators: IP65/IP67.

Connector assignment

M12 connector socket, 4-pole

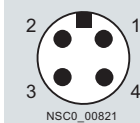

- 1 ASi +
- 2 Not assigned
- 3 ASi -
- 4 Not assigned

M12 socket, 4-pole

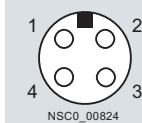

- 1 Channel 2
- 2 Not assigned
- 3 Channel 2
- 4 Not assigned

LEDs

Status display (operating state)

LEDs	No voltage on AS-Interface chip	Communication OK	Communication failed	Slave has address "0"
ASi/Fault (GN/RD)				

Safe inputs

LEDs	Not actuated	Actuated		
F-IN1 (YE)				
F-IN2 (YE)				

SIRIUS 3SF1 Mechanical Safety Switches for AS-Interface

Plastic enclosures



Enclosure width 31 mm acc. to EN 50047 / 50 mm

Selection and ordering data

Modular system

For the ASIsafe version of the position switch, the basic switch and actuator must be ordered separately.

1 or 2 contacts · 3 LEDs · Degree of protection IP65 (31 mm) or IP66/IP67 (50 mm) · M12 connector socket

Version	Contacts	LEDs	DT	Modular system	PU (UNIT, SET, M)	PS*	PG
							
							
				Order No.	Price per PU		

Basic switches (with rounded plunger¹⁾) - Enclosure width 31 mm acc. to EN 50047



With teflon plunger

With M12 connector socket, 4-pole, channel 1 on NC contact, channel 2 on NC contact

Slow-action contacts	2 NC	24 V DC		B	3SF1 234-1KC05-1BA1	1	1 unit	42A
Snap-action contacts	2 NC	24 V DC		B	3SF1 234-1LC05-1BA1	1	1 unit	42A

ASIsafe basic switch

Basic switches (with rounded plunger¹⁾) - Enclosure width 50 mm



With teflon plunger

With M12 connector socket, 4-pole, channel 1 on NC contact, channel 2 on M12 socket, right

Slow-action contacts	1 NC	24 V DC		B	3SF1 244-1KC05-1BA2	1	1 unit	42A
Snap-action contacts	1 NC	24 V DC		B	3SF1 244-1LC05-1BA2	1	1 unit	42A

ASIsafe basic switch

 For online configurator see www.siemens.com/sirius/configurators.

 Positive opening according to IEC 60947-5-1, Appendix K, or positive drive for use in safety circuits.







¹⁾ For enclosures with widths of 31 mm and 50 mm, the basic switch is a complete unit with rounded plungers.

Note:

Selection aid see page 12/12.

SIRIUS 3SF1 Mechanical Safety Switches for AS-Interface

Plastic enclosures
Enclosure width 31 mm acc. to EN 50047 / 50 mm

Version	Roller diameter	DT	Modular system	PU (UNIT, SET, M)	PS*	PG	
	mm		Order No.	Price per PU			
Operating mechanisms							
 Roller plunger	Roller plungers, type C acc. to EN 50047						
	Plastic roller	10	⊕ A	3SE5 000-0AD03	1	1 unit	41K
	High-grade steel roller	10	⊕ B	3SE5 000-0AD04	1	1 unit	41K
 With central fixing	Roller plungers with central fixing						
	Plastic roller	10	⊕ B	3SE5 000-0AD10	1	1 unit	41K
	High-grade steel roller	10	⊕ B	3SE5 000-0AD11	1	1 unit	41K
 Roller lever	Roller levers, type E acc. to EN 50047						
	Metal lever, plastic roller	13	⊕ A	3SE5 000-0AE10	1	1 unit	41K
	Metal lever, high-grade steel roller	13	⊕ B	3SE5 000-0AE11	1	1 unit	41K
	High-grade steel roller, plastic roller	13	⊕ B	3SE5 000-0AE12	1	1 unit	41K
	High-grade steel lever, high-grade steel roller	13	⊕ B	3SE5 000-0AE13	1	1 unit	41K
 Angular roller lever	Angular roller levers						
	Metal lever, plastic roller	13	⊕ A	3SE5 000-0AF10	1	1 unit	41K
	Metal lever, high-grade steel roller	13	⊕ B	3SE5 000-0AF11	1	1 unit	41K
	High-grade steel lever, plastic roller	13	⊕ A	3SE5 000-0AF12	1	1 unit	41K
	High-grade steel lever, high-grade steel roller	13	⊕ B	3SE5 000-0AF13	1	1 unit	41K
Twist actuators with lever							
 Twist actuator	Twist actuators, plastic (without lever)						
	Switching right or left, adjustable		⊕ A	3SE5 000-0AK00	1	1 unit	41K
Levers for twist actuators							
 Twist lever	Twist levers, type A acc. to EN 50047						
	Metal lever, plastic roller	19	⊕ A	3SE5 000-0AA21	1	1 unit	41K
	Metal lever, high-grade steel roller	19	⊕ B	3SE5 000-0AA22	1	1 unit	41K
	Metal lever, roller with ball bearing	19	⊕ B	3SE5 000-0AA23	1	1 unit	41K
	Metal lever, plastic roller	30	⊕ B	3SE5 000-0AA25	1	1 unit	41K
	High-grade steel lever, plastic roller	19	⊕ B	3SE5 000-0AA31	1	1 unit	41K
 Twist lever, adjustable length	High-grade steel lever, high-grade steel roller	19	⊕ B	3SE5 000-0AA32	1	1 unit	41K
	Twist levers 30 mm, straight¹⁾						
	Metal lever, plastic roller	19	⊕ B	3SE5 000-0AA24	1	1 unit	41K
	Metal lever, plastic roller	30	⊕ B	3SE5 000-0AA26	1	1 unit	41K
Twist levers, adjustable length, with grid hole							
Metal lever, plastic roller	19	⊕ B	3SE5 000-0AA60	1	1 unit	41K	
Metal lever, high-grade steel roller	19	⊕ B	3SE5 000-0AA61	1	1 unit	41K	
Metal lever, plastic roller	50	⊕ B	3SE5 000-0AA67	1	1 unit	41K	
Metal lever, rubber roller	50	⊕ B	3SE5 000-0AA68	1	1 unit	41K	
High-grade steel lever, plastic roller	19	⊕ B	3SE5 000-0AA62	1	1 unit	41K	
High-grade steel lever, high-grade steel roller	19	⊕ B	3SE5 000-0AA63	1	1 unit	41K	

⊕ Positive drive, for use in safety circuits.

¹⁾ Can be clinch mounted (turned through 180°, rear of lever).

SIRIUS 3SF1 Mechanical Safety Switches for AS-Interface



Metal enclosures
Enclosure width 31 mm acc. to EN 50047

Selection and ordering data

Modular system

For the ASIsafe version of the position switch, the basic switch and actuator must be ordered separately.

2 contacts · 3 LEDs · Degree of protection IP66/IP67 · M12 connector socket

Version	Contacts	LEDs	DT	Modular system	PU (UNIT, SET, M)	PS*	PG
							
							
				Order No.	Price per PU		

Basic switches (with rounded plunger¹⁾) - Enclosure width 31 mm acc. to EN 50047



With plunger

With M12 connector socket, 4-pole, channel 1 on NC contact, channel 2 on NC contact

Slow-action contacts	2 NC	24 V DC		B	3SF1 214-1KC05-1BA1	1	1 unit	42A
Snap-action contacts	2 NC	24 V DC		B	3SF1 214-1LC05-1BA1	1	1 unit	42A

ASIsafe basic switch

 For online configurator see www.siemens.com/sirius/configurators.

 Positive opening according to IEC 60947-5-1, Appendix K, or positive drive for use in safety circuits.









¹⁾ For enclosures with widths of 31 mm, the basic switch is a complete unit with rounded plungers.

Note:

Selection aid [see page 12/12](#).

SIRIUS 3SF1 Mechanical Safety Switches for AS-Interface

Metal enclosures
Enclosure width 31 mm acc. to EN 50047

Version	Roller diameter	DT	Modular system	PU (UNIT, SET, M)	PS*	PG
	mm		Order No.	Price per PU		
Operating mechanisms						
 Plain plunger	Plain plungers High-grade steel plunger	10	⊕ A	3SE5 000-0AB01	1	1 unit 41K
 Roller plunger	Roller plungers, type C acc. to EN 50047 Plastic roller High-grade steel roller	10 10	⊕ A ⊕ B	3SE5 000-0AD03 3SE5 000-0AD04	1 1	1 unit 41K 1 unit 41K
 With central fixing	Roller plungers with central fixing Plastic roller High-grade steel roller	10 10	⊕ B ⊕ B	3SE5 000-0AD10 3SE5 000-0AD11	1 1	1 unit 41K 1 unit 41K
 Roller lever	Roller levers, type E acc. to EN 50047 Metal lever, plastic roller Metal lever, high-grade steel roller High-grade steel lever, plastic roller High-grade steel lever, high-grade steel roller	13 13 13 13	⊕ A ⊕ B ⊕ B ⊕ B	3SE5 000-0AE10 3SE5 000-0AE11 3SE5 000-0AE12 3SE5 000-0AE13	1 1 1 1	1 unit 41K 1 unit 41K 1 unit 41K 1 unit 41K
 Angular roller lever	Angular roller levers Metal lever, plastic roller Metal lever, high-grade steel roller High-grade steel lever, plastic roller High-grade steel lever, high-grade steel roller	13 13 13 13	⊕ A ⊕ B ⊕ A ⊕ B	3SE5 000-0AF10 3SE5 000-0AF11 3SE5 000-0AF12 3SE5 000-0AF13	1 1 1 1	1 unit 41K 1 unit 41K 1 unit 41K 1 unit 41K
Twist actuators with lever						
 Twist actuator	Twist actuators, plastic (without lever) Switching right or left, adjustable		⊕ A	3SE5 000-0AK00	1	1 unit 41K
 Twist lever	Levers for twist actuators Twist levers, type A acc. to EN 50047 Metal lever, plastic roller Metal lever, high-grade steel roller Metal lever, roller with ball bearing Metal lever, plastic roller High-grade steel lever, plastic roller High-grade steel lever, high-grade steel roller	19 19 19 30 19 19	⊕ A ⊕ B ⊕ B ⊕ B ⊕ B ⊕ B	3SE5 000-0AA21 3SE5 000-0AA22 3SE5 000-0AA23 3SE5 000-0AA25 3SE5 000-0AA31 3SE5 000-0AA32	1 1 1 1 1 1	1 unit 41K 1 unit 41K 1 unit 41K 1 unit 41K 1 unit 41K 1 unit 41K
 Twist lever, adjustable length	Twist levers 30 mm, straight¹⁾ Metal lever, plastic roller Metal lever, plastic roller	19 30	⊕ B ⊕ B	3SE5 000-0AA24 3SE5 000-0AA26	1 1	1 unit 41K 1 unit 41K
	Twist levers, adjustable length, with grid hole Metal lever, plastic roller Metal lever, high-grade steel roller Metal lever, plastic roller Metal lever, rubber roller High-grade steel lever, plastic roller High-grade steel lever, high-grade steel roller	19 19 50 50 19 19	⊕ B ⊕ B ⊕ B ⊕ B ⊕ B ⊕ B	3SE5 000-0AA60 3SE5 000-0AA61 3SE5 000-0AA67 3SE5 000-0AA68 3SE5 000-0AA62 3SE5 000-0AA63	1 1 1 1 1 1	1 unit 41K 1 unit 41K 1 unit 41K 1 unit 41K 1 unit 41K 1 unit 41K

⊕ Positive drive, for use in safety circuits.

¹⁾ Can be clinch mounted (turned through 180°, rear of lever).

SIRIUS 3SF1 Mechanical Safety Switches for AS-Interface

Metal enclosures

Enclosure width 40 mm acc. to EN 50041 / 56 mm

Selection and ordering data

Modular system

For the ASIsafe version of the position switch, the basic switch and actuator must be ordered separately.

1 or 2 contacts · 3 LEDs · Degree of protection IP66/IP67 · M12 connector socket

Version	Contacts	LEDs	DT	Modular system	PU (UNIT, SET, M)	PS*	PG
				Configurator			
				Order No.	Price per PU		

Basic switches - Enclosure width 40 mm acc. to EN 50041



With M12 connector socket, 4-pole, channel 1 on NC contact, channel 2 on NC contact

Slow-action contacts	2 NC	24 V DC		B	3SF1 114-1KA00-1BA1	1	1 unit	42A
Snap-action contacts	2 NC	24 V DC		B	3SF1 114-1LA00-1BA1	1	1 unit	42A

ASIsafe basic switch

Basic switches - Enclosure width 56 mm



With M12 connector socket, 4-pole, channel 1 on NC contact, channel 2 on M12 socket, right

Slow-action contacts	1 NC	24 V DC		B	3SF1 124-1KA00-1BA2	1	1 unit	42A
Snap-action contacts	1 NC	24 V DC		B	3SF1 124-1LA00-1BA2	1	1 unit	42A

ASIsafe basic switch

For online configurator see www.siemens.com/sirius/configurators.

Positive opening according to IEC 60947-5-1, Appendix K, or positive drive for use in safety circuits.

Note:

Selection aid see page 12/12.

Version	Roller diameter	DT	Modular system	PU (UNIT, SET, M)	PS*	PG
	mm					
			Order No.	Price per PU		

Operating mechanisms



Plain plunger

Plain plungers

High-grade steel plunger	10		A	3SE5 000-0AB01	1	1 unit	41K
--------------------------	----	--	---	-----------------------	---	--------	-----



Rounded plunger

Rounded plungers, type B, acc. to EN 50041

High-grade steel plunger, with 3 mm overtravel	12		B	3SE5 000-0AC02	1	1 unit	41K
--	----	--	---	-----------------------	---	--------	-----



Roller plunger









Roller plungers, type C acc. to EN 50041

High-grade steel roller, with 3 mm overtravel	13		B	3SE5 000-0AD02	1	1 unit	41K
---	----	--	---	-----------------------	---	--------	-----

Positive drive, for use in safety circuits.

SIRIUS 3SF1 Mechanical Safety Switches for AS-Interface

Metal enclosures
Enclosure width 40 mm acc. to EN 50041 / 56 mm

Version	Roller diameter	DT	Modular system	PU (UNIT, SET, M)	PS*	PG	
	mm		Order No.	Price per PU			
Operating mechanisms							
	Roller levers						
	Metal lever, plastic roller	22	⊕ A	3SE5 000-0AE01	1	1 unit 41K	
	Metal lever, high-grade steel roller	22	⊕ B	3SE5 000-0AE02	1	1 unit 41K	
	High-grade steel lever, plastic roller	22	⊕ B	3SE5 000-0AE03	1	1 unit 41K	
	Angular roller levers						
	Metal lever, plastic roller	22	⊕ A	3SE5 000-0AF01	1	1 unit 41K	
	Metal lever, high-grade steel roller	22	⊕ B	3SE5 000-0AF02	1	1 unit 41K	
	High-grade steel lever, plastic roller	22	⊕ B	3SE5 000-0AF03	1	1 unit 41K	
	Twist actuators, metal (without lever)						
	• For twist levers, switching right or left, adjustable						
	- For enclosure width 40 and 56 mm		⊕ A	3SE5 000-0AH00	1	1 unit 41K	
	• For fork levers, latching		⊕ B	3SE5 000-0AT10	1	1 unit 41K	
Levers for twist actuators							
Twist levers 27 mm, offset, type A, acc. to EN 50041							
	Metal lever, plastic roller	19	⊕ A	3SE5 000-0AA01	1	1 unit 41K	
	Metal lever, high-grade steel roller	19	⊕ A	3SE5 000-0AA02	1	1 unit 41K	
	Metal lever, roller with ball bearing	19	⊕ B	3SE5 000-0AA03	1	1 unit 41K	
	Metal lever, 2 plastic rollers	19	⊕ B	3SE5 000-0AA04	1	1 unit 41K	
	Metal lever, plastic roller	30	⊕ B	3SE5 000-0AA05	1	1 unit 41K	
	Metal lever, plastic roller	50	⊕ B	3SE5 000-0AA07	1	1 unit 41K	
	Metal lever, rubber roller	50	⊕ B	3SE5 000-0AA08	1	1 unit 41K	
	High-grade steel lever, plastic roller	19	⊕ B	3SE5 000-0AA11	1	1 unit 41K	
	High-grade steel lever, high-grade steel roller	19	⊕ B	3SE5 000-0AA12	1	1 unit 41K	
	Twist levers 35 mm, offset						
	Metal lever, plastic roller	19	⊕ B	3SE5 000-0AA15	1	1 unit 41K	
	Twist levers 30 mm, straight¹⁾						
	Metal lever, plastic roller	19	⊕ B	3SE5 000-0AA24	1	1 unit 41K	
	Metal lever, plastic roller	30	⊕ B	3SE5 000-0AA26	1	1 unit 41K	
Twist levers, adjustable length, with grid hole							
	Metal lever, plastic roller	19	⊕ B	3SE5 000-0AA60	1	1 unit 41K	
	Metal lever, high-grade steel roller	19	⊕ B	3SE5 000-0AA61	1	1 unit 41K	
	Metal lever, plastic roller	50	⊕ B	3SE5 000-0AA67	1	1 unit 41K	
	Metal lever, rubber roller	50	⊕ B	3SE5 000-0AA68	1	1 unit 41K	
	High-grade steel lever, plastic roller	19	⊕ B	3SE5 000-0AA62	1	1 unit 41K	
	High-grade steel lever, high-grade steel roller	19	⊕ B	3SE5 000-0AA63	1	1 unit 41K	
Fork levers (for switches with snap-action contacts only)							
	Metal lever, 2 plastic rollers	19	⊕ B	3SE5 000-0AT01	1	1 unit 41K	
	Metal lever, 2 high-grade steel rollers	19	⊕ B	3SE5 000-0AT02	1	1 unit 41K	
	High-grade steel lever, 2 plastic rollers	19	⊕ B	3SE5 000-0AT03	1	1 unit 41K	
	High-grade steel lever, 2 high-grade steel rollers	19	⊕ B	3SE5 000-0AT04	1	1 unit 41K	

⊕ Positive drive, for use in safety circuits.

¹⁾ Can be clinch mounted (turned through 180°, rear of lever).

SIRIUS 3SF1 Mechanical Safety Switches for AS-Interface

With Separate Actuator

General data

Overview

The 3SF1 position switches with safety-oriented communication can be directly connected using the AS-Interface bus system. The safety functions no longer have to be conventionally wired up.

With the 3SF1 position switches the ASIsafe electronics are integrated in the switch enclosure.



3SF1 position switches with head for separate actuator and with integrated ASIsafe electronics

3SF1 position switches with separate actuator have the same enclosures as the standard switches.

Operation

The actuator head is included in the scope of supply. For actuation from four directions it can be adjusted through $4 \times 90^\circ$. The switches can also be approached from above.

The actuator is not included in the scope of supply for the position switch and must be ordered separately, with a choice of variations depending on application.

The actuator is encoded. Simple overruling by hand or auxiliary devices is impossible.

A high-grade steel blocking insert for attaching up to eight padlocks is available for even more safety.

A rubber cap to protect the metal enclosure from contamination is available for operation in dusty environments.

Display

The switches have a status display with three LEDs:

- LED 1 (yellow): F-IN1
- LED 2 (yellow): F-IN2
- LED 3 (green/red): AS-i/FAULT

Connection

Connection to the AS-Interface is by means of a 4-pole M12 connector socket (plastic version) connected to the yellow AS-Interface bus cable.

The wide enclosures (50 or 56 mm) also have an M12 socket for connecting a second position switch. Category 4 according to EN 954-1 is thus achieved.

Benefits

The new generation of 3SF1 position switches with separate actuator offers:

- ASIsafe Electronics integrated in the enclosure, with low power consumption $< 60 \text{ mA}$
- An extensive range of actuators
- Status display with three LEDs

Application

Position switches with separate actuator are used where the position of doors, covers or protective grills must be monitored for safety reasons.

The position switch can only be operated with the matching coded actuator. Simple overruling by hand or auxiliary devices is impossible.

Devices are available with enclosure versions to suit the particular ambient conditions. Different control tasks can be performed with the best contact blocks suited for the particular purpose. Dimensions, fixing points of the enclosure are in accordance with EN 50041 or EN 50047 standards.

The devices are suitable for use in any climate.

Standards

The switches comply with the standards IEC 60947-1 (Low-Voltage Switchgear and Controlgear, General) and IEC 60947-5-1 (Electromechanical Control Circuit Devices).

The mechanical design of the switch corresponds to the requirements of the failsafe principle according to EN 1088.

Approvals

AS-Interface according to EN 50295 and IEC 62026-2.

With a 3SF1 position switch it is possible to achieve category 3 according to ISO 13849-1 (EN 954-1) or SIL 2 according to IEC 61508.

Category 4 according to ISO 13849-1 (EN 954-1) or SIL 3 according to IEC 61508 can be achieved by using a second 3SE5 position switch.

The 3SF1 position switches are approved according to UL 508, UL 50 and UL 746-C.

SIRIUS 3SF1 Mechanical Safety Switches for AS-Interface

With Separate Actuator

Plastic enclosures
Enclosure width 31 mm / 50 mm

Overview

- Contacts: 1 or 2 slow-action contacts
- Status display with 3 LEDs 24 V DC;
1: F-IN1, 2: F-IN2, 3: AS-I/FAULT
- Degree of protection IP65 (31 mm) or IP66/IP67 (50 mm)

Selection and ordering data

Version ¹⁾	Contacts	DT	Complete units	PU (UNIT, SET, M)	PS*	PG
			Configurator			
			Order No.	Price per PU		

Enclosure width 31 mm acc. to EN 50047



5 directions of approach

With M12 connector socket, 4-pole;
channel 1 on NC contact,
channel 2 on NC contact
Slow-action contacts

2 NC

⊕ B

3SF1 234-1QV40-1BA1

1

1 unit

42A

Enclosure width 50 mm



5 directions of approach

With M12 connector socket, 4-pole;
channel 1 on NC,
channel 2 on M12 socket, right
Slow-action contacts

1 NC

⊕ B

3SF1 244-1QV40-1BA2

1

1 unit

42A

For online configurator see www.siemens.com/sirius/configurators.

⊕ Positive opening according to IEC 60947-5-1, Appendix K.

¹⁾ Supplied without actuator. Please order separately (see page 12/97).

SIRIUS 3SF1 Mechanical Safety Switches for AS-Interface





With Separate Actuator

Metal enclosures
Enclosure width 31 mm / 40 mm / 56 mm

Overview

- Contacts: 1 or 2 slow-action contacts
- Status display with 3 LEDs 24 V DC;
1: F-IN1, 2: F-IN2, 3: AS-I/FAULT
- Degree of protection IP66/IP67

Selection and ordering data

Version ¹⁾	Contacts	DT	Complete units	PU (UNIT, SET, M)	PS*	PG
						
						
			Order No.	Price per PU		
Enclosure width 31 mm acc. to EN 50047						
	5 directions of approach With M12 connector socket, 4-pole; channel 1 on NC contact, channel 2 on NC contact Slow-action contacts	2 NC	⊕ B	3SF1 214-1QV40-1BA1	1	1 unit 42A
Enclosure width 40 mm acc. to EN 50041						
	5 directions of approach With M12 connector socket, 4-pole; channel 1 on NC contact, channel 2 on NC contact Slow-action contacts	2 NC	⊕ B	3SF1 114-1QV10-1BA1	1	1 unit 42A
Enclosure width 56 mm						
	5 directions of approach With M12 connector socket, 4-pole; channel 1 on NC, channel 2 on M12 socket, right Slow-action contacts	1 NC	⊕ B	3SF1 124-1QV10-1BA2	1	1 unit 42A

 For online configurator see www.siemens.com/sirius/configurators.

 Positive opening according to IEC 60947-5-1, Appendix K.











¹⁾ Supplied without actuator. Please order separately (see page 12/97).

SIRIUS 3SF1 Mechanical Safety Switches for AS-Interface

With Separate Actuator

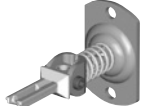
Accessories

Overview

Version	DT	Order No.	Price per PU	PU (UNIT, SET, M)	PS*	PG
Actuators						
 3SE5 000-0AV01		▶ 3SE5 000-0AV01		1	1 unit	41K
 3SE5 000-0AV02	A	3SE5 000-0AV02		1	1 unit	41K
 3SE5 000-0AV03	A	3SE5 000-0AV03		1	1 unit	41K
 3SE5 000-0AW11	B	3SE5 000-0AW11		1	1 unit	102
 3SE5 000-0AV04	A	3SE5 000-0AV04		1	1 unit	41K
 3SE5 000-0AV6	A	3SE5 000-0AV06		1	1 unit	41K
 3SE5 000-0AV05-1AA6	A	3SE5 000-0AV05		1	1 unit	41K
	A	3SE5 000-0AV05-1AA6		1	1 unit	41K
 3SE5 000-0AV07	A	3SE5 000-0AV07-1AK2		1	1 unit	41K
	A	3SE5 000-0AV07		1	1 unit	41K
Optional accessories						
 3SE5 000-0AV08-1AA2	B	3SE5 000-0AV08-1AA2		1	1 unit	41K
 3SE5 000-0AV08-1AA3	C	3SE5 000-0AV08-1AA3		1	1 unit	41K

¹⁾ Not suitable for safety switches with interlocking.

SIRIUS 3SF1 Mechanical Safety Switches for AS-Interface

With Solenoid Interlocking

General data

Overview

The 3SF1 position switches with safety-oriented communication can be directly connected using the AS-Interface bus system. The safety functions no longer have to be conventionally wired up.

With the 3SF1 position switches the ASIsafe electronics are integrated in the switch enclosure.



3SF1 position switch with solenoid interlocking and with integrated ASIsafe electronics

Operation

The actuator head is included in the scope of supply. For actuation from four directions it can be adjusted through $4 \times 90^\circ$. The switches can also be approached from above.

The actuator is not included in the scope of supply for the position switch and must be ordered separately, with a choice of variations depending on application.

The actuator is encoded. Simple overruling by hand or auxiliary devices is impossible.

A high-grade steel blocking insert for attaching up to eight padlocks is available for even more safety.

A rubber cap to protect the enclosure from contamination is available for operation in dusty environments.

Solenoid interlocking

There are two versions for interlocking the actuator:

- Spring-actuated lock (closed-circuit principle) with various release mechanisms
- Solenoid-locked (open-circuit principle)

For more explanations see page 12/66.

Display

The switches have a status display with four LEDs:

- LED 1 (green): AS-i
- LED 2 (red): FAULT
- LED 3 (yellow): F-IN1
- LED 4 (yellow): F-IN2

Connection

Connection to the AS-Interface is by means of a 4-pole M12 connector socket (plastic version) connected to the yellow AS-Interface bus cable (no additional supply of auxiliary power is required thanks to the low current consumption of the solenoid of max. 170 mA).

Benefits

The new generation of 3SF1 3 position switches with solenoid interlocking offers:

- More safety through higher locking forces:
 - 1300 N for the plastic version
 - 2600 N for the metal version
- Various release mechanisms: Lock release, escape release and emergency release
- ASIsafe Electronics integrated in the enclosure; connected through 4-pole M12 connector socket
- Current consumption of the solenoid max. 170 mA
- Two contact blocks as standard equipment, hence fewer versions needed
- Same dimensions for all enclosure versions: Plastic, metal
- An extensive range of actuators
- Status display with four LEDs

Application

The position switches with solenoid interlocking are exceptional safety-related devices which prevent an unforeseen or intentional opening of protective doors, protective grills or other covers as long as a dangerous situation is present (i.e. follow-on motion of the switched off machine).

The safety position switches with solenoid interlocking have the following functions:

- Enabling the machine or process with closed and locked protective device
- Locking the machine or process with opened protective device
- Position monitoring of the protective device and interlocking

Standards

The switches comply with the standards IEC 60947-1 (Low-Voltage Switchgear and Controlgear, General) and IEC 60947-5-1 (Electromechanical Control Circuit Devices).

The mechanical design of the switch corresponds to the requirements of the failsafe principle according to EN 1088.

Approvals

AS-Interface according to EN 50295 and IEC 62026-2.

The switches are approved for use with locking devices according to EN 1088 and EN 292, Parts 1 and 2.

The 3SF1 3 position switches with interlocking have a VDE test marking.

With a 3SF1 3 position switch with solenoid interlocking it is possible to achieve category 3 according to ISO 13849-1 (EN 954-1) or SIL 2 according to IEC 61508.

Category 4 according to ISO 13849-1 (EN 954-1) or SIL 3 according to IEC 61508 can be achieved by using a second 3SE5 position switch.

The 3SF1 position switches are approved according to UL 508, UL 50 and UL 746-C.

SIRIUS 3SF1 Mechanical Safety Switches for AS-Interface

With Solenoid Interlocking

Plastic enclosures
With locking force greater than 1200 N

Overview

5 directions of approach · Degree of protection IP66/IP67

- Slow-action contacts:
 - Version -1BA1: ASIsafe channel 1 on 1 NC contact from the actuator and channel 2 on 1 NC contact from the solenoid
 - Version -1BA3: ASIsafe channel 1 on the first NC contact from the actuator and channel 2 on the second NC contact from the actuator
 - Version -1BA4: ASIsafe channel 1 on 2 NC contacts from the actuator and channel 2 on 1 NC contact from the solenoid. A discrepancy between the two contacts of the actuator will be evaluated already in the switch.
- Solenoid: Rated operational voltage 24 V DC
- Locking force 1300 N (1000 N according to GS-ET 19)
- Status display with 4 LEDs 24 V DC;
 - 1: AS-i, 2: FAULT, 3: F-IN1, 4: F-IN2

Safety level

The new 3SF1 324-1S.21-1BA4 safety position switches are also recommended in the case of several protective door interlockings where reliable diagnostics and quick restart capability of equipment is required.

- A response is received from the magnet.
- No opening of the doors after the solenoid is unlocked.

With AS-i safety monitor or in DP/AS-i F-Link it is possible to achieve SIL 2 according to IEC 61508 or PL d according to ISO 13849-1.

Comparison of versions

Safety switch	Contacts	Achievable safety level	Diagnostics	Reclose condition after unlocking the solenoid (depending on the type of evaluation)
Type	Actuator / magnet		Feedback from the solenoid	
3SF1 324-1S.21-1BA1	1 NC/1 NC	SIL 1 / PL c	✓	Door does <u>not</u> have to be opened
	1 NC/1 NC	SIL 2 / PL d	✓	Door must be opened
3SF1 324-1S.21-1BA3	2 NC	SIL 2 / PL d	--	Door does <u>not</u> have to be opened
3SF1 324-1S.21-1BA4	2 NC/1 NC	SIL 2 / PL d	✓	Door does <u>not</u> have to be opened

Selection and ordering data

Interlock ¹⁾	Contacts Actuators/ Solenoids	DT	Complete units <input type="checkbox"/>	Configurator	Order No.	Price per PU	PU (UNIT, SET, M)	PS*	PG
1300 N locking force · Enclosure width 54 mm									
	Spring-actuated locks								
	• With auxiliary release	1 NC/1 NC	⊕ B	3SF1 324-1SD21-1BA1			1	1 unit	42A
		2 NC/--	⊕ B		3SF1 324-1SD21-1BA3		1	1 unit	42A
		2 NC/1 NC	⊕ B		3SF1 324-1SD21-1BA4		1	1 unit	42A
• With auxiliary release with lock	1 NC/1 NC	⊕ B	3SF1 324-1SE21-1BA1			1	1 unit	42A	
	• With escape release from the front	1 NC/1 NC	⊕ B	3SF1 324-1SF21-1BA1			1	1 unit	42A
		2 NC/1 NC	⊕ B		3SF1 324-1SF21-1BA4		1	1 unit	42A
	• With escape release from the back and auxiliary release from the front	1 NC/1 NC	⊕ B		3SF1 324-1SG21-1BA1		1	1 unit	42A
		2 NC/1 NC	⊕ B		3SF1 324-1SG21-1BA4		1	1 unit	42A
	• With emergency release from the back and auxiliary release from the front	1 NC/1 NC	⊕ B		3SF1 324-1SJ21-1BA1		1	1 unit	42A
	Solenoid locks								
		1 NC/1 NC	⊕ B	3SF1 324-1SB21-1BA1			1	1 unit	42A
	2 NC/--	⊕ B	3SF1 324-1SB21-1BA3			1	1 unit	42A	

For online configurator see www.siemens.com/sirius/configurators.

Positive opening according to IEC 60947-5-1, Appendix K.

¹⁾ Supplied without actuator. Please order separately.

For actuators and optional accessories see page 12/97.

SIRIUS 3SF1 Mechanical Safety Switches for AS-Interface

With Solenoid Interlocking

Metal enclosures
With locking force greater than 2000 N

Overview



5 directions of approach · Degree of protection IP66/IP67

- Slow-action contacts:
Version -1BA1: ASIsafe channel 1 on 1 NC contact from the actuator and channel 2 on 1 NC contact from the solenoid
- Solenoid: Rated operational voltage 24 V DC
- Locking force 2600 N (2000 N according to GS-ET 19)
- Status display with 4 LEDs 24 V DC;
1: AS-i, 2: FAULT, 3: F-IN1, 4: F-IN2

Safety level

See page 12/99.

Selection and ordering data

Interlock ¹⁾	Contacts Actuators/ Solenoids	DT	Complete units	<input type="checkbox"/>	PU (UNIT, SET, M)	PS*	PG
			Configurator				
			Order No.	Price per PU			
2600 N locking force · Enclosure width 54 mm							
	Spring-actuated locks						
	• With auxiliary release	1 NC/1 NC	⊕ B	3SF1 314-1SD11-1BA1	1	1 unit	42A
	• With auxiliary release with lock	1 NC/1 NC	⊕ B	3SF1 314-1SE11-1BA1	1	1 unit	42A
3SF1 314-1SD11-...							
	• With escape release from the front	1 NC/1 NC	⊕ B	3SF1 314-1SF11-1BA1	1	1 unit	42A
	• With escape release from the back and auxiliary release from the front	1 NC/1 NC	⊕ B	3SF1 314-1SG11-1BA1	1	1 unit	42A
	• With escape release from the back and auxiliary release with lock from the front	1 NC/1 NC	⊕ B	3SF1 314-1SH11-1BA1	1	1 unit	42A
	• With emergency release from the back and auxiliary release from the front	1 NC/1 NC	⊕ B	3SF1 314-1SJ11-1BA1	1	1 unit	42A
3SF1 314-1SF11-...							
	Solenoid locks	1 NC/1 NC	⊕ B	3SF1 314-1SB11-1BA1	1	1 unit	42A
3SF1 314-1SB11-...							

For online configurator see www.siemens.com/sirius/configurators.

⊕ Positive opening according to IEC 60947-5-1, Appendix K.

¹⁾ Supplied without actuator. Please order separately.

For actuators and optional accessories see page 12/97.

SIRIUS 3SF1 Mechanical Safety Switches for AS-Interface

Hinge Switches

Plastic enclosures
Enclosure width 31 mm / 50 mm

Overview

The 3SF1 hinge switches with safety-oriented communication can be directly connected using the AS-Interface bus system. The safety functions no longer have to be conventionally wired up.

With the 3SF1 position switches the ASIsafe electronics are integrated in the switch enclosure.

The hinge switches are provided for mounting on hinges. There are two actuator versions here:

- Hollow shaft, inner diameter 8 mm, outer 12 mm
- Solid shaft, diameter 10 mm

For the ASIsafe version of the hinge switch, the basic switch and actuator head must be ordered separately. The basic switches correspond to the position switches of the standard version (only use versions with snap-action contacts).

The standards and approvals are the same as for the 3SF1 standard switches (see page 12/86).

Selection and ordering data

Modular system

1 or 2 contacts · 3 LEDs · Degree of protection IP65 (31 mm) or IP66/IP67 (50 mm) · M12 connector socket

Version	Contacts	LEDs	DT	Modular system	PU (UNIT, SET, M)	PS*	PG
				Configurator			
				Order No.	Price per PU		

Basic switches · Enclosure width 31 mm acc. to EN 50047



With teflon plunger, with M12 connector socket, 4-pole, channel 1 on NC contact, channel 2 on NC contact

Snap-action contacts 2 NC

24 V DC ⊕ B

3SF1 234-1LC05-1BA1

1 1 unit 42A

ASIsafe basic switch

Basic switches · Enclosure width 50 mm



With teflon plunger, with M12 connector socket, 4-pole, channel 1 on NC contact, channel 2 on M12 socket, right

Snap-action contacts 1 NC

24 V DC ⊕ B

3SF1 244-1LC05-1BA2

1 1 unit 42A

ASIsafe basic switch

Actuator heads



Twist actuator with hollow shaft

With hollow shaft

Operating angle 10°

B

3SE5 000-0AU21

1 1 unit 41K



Twist actuator with solid shaft

With solid shaft

Operating angle 10°

B

3SE5 000-0AU22

1 1 unit 41K

⚙ For online configurator see www.siemens.com/sirius/configurators.

⊕ Positive opening according to IEC 60947-5-1, Appendix K.

SIRIUS 3SF1 Mechanical Safety Switches for AS-Interface

Hinge Switches

Metal enclosures

Enclosure width 31 mm / 40 mm / 56 mm

Overview

The 3SF1 hinge switches with safety-oriented communication can be directly connected using the AS-Interface bus system. The safety functions no longer have to be conventionally wired up.

With the 3SF1 position switches the ASIsafe electronics are integrated in the switch enclosure.

The hinge switches are provided for mounting on hinges. There are two actuator versions here:

- Hollow shaft, inner diameter 8 mm, outer 12 mm
- Solid shaft, diameter 10 mm



For the ASIsafe version of the hinge switch, the basic switch and actuator head must be ordered separately. The basic switches correspond to the position switches of the standard version (only use versions with snap-action contacts).

The standards and approvals are the same as for the 3SF1 standard switches (see page 12/86).

Selection and ordering data

Modular system

1 or 2 contacts · 3 LEDs · Degree of protection IP66/IP67 · M12 connector socket

Version	Contacts	LEDs	DT	Modular system	PU (UNIT, SET, M)	PS*	PG
							
							
				Order No.	Price per PU		

Basic switches · Enclosure width 31 mm acc. to EN 50047



With plunger

With M12 connector socket, 4-pole, channel 1 on NC contact, channel 2 on NC contact

Snap-action contacts

2 NC

24 V DC

 B

3SF1 214-1LC05-1BA1

1

1 unit

42A

ASIsafe basic switch

Basic switches · Enclosure width 40 mm acc. to EN 50041



With M12 connector socket, 4-pole, channel 1 on NC contact, channel 2 on NC contact

Snap-action contacts

2 NC

24 V DC

 B

3SF1 114-1LA00-1BA1

1

1 unit

42A

ASIsafe basic switch

Basic switches · Enclosure width 56 mm



With M12 connector socket, 4-pole, channel 1 on NC contact, channel 2 on M12 socket, right

Snap-action contacts

1 NC

24 V DC

 B

3SF1 124-1LA00-1BA2

1

1 unit

42A

ASIsafe basic switch

Actuator heads



Twist actuator with hollow shaft

Hollow shafts

Operating angle 10°

B

3SE5 000-0AU21

1

1 unit

41K



Twist actuator with solid shaft

Solid shafts

Operating angle 10°

B

3SE5 000-0AU22

1

1 unit

41K

 For online configurator see www.siemens.com/sirius/configurators.

 Positive opening according to IEC 60947-5-1, Appendix K.

Overview



Switching magnets and contact blocks

A magnetically operated switch is comprised of a coded switching magnet and a contact block (sensor unit). Evaluation requires a safety relay or connection to a bus system.

3SE6 806 safety relays

Up to six protective devices (sensors) can be connected to the safety relay.

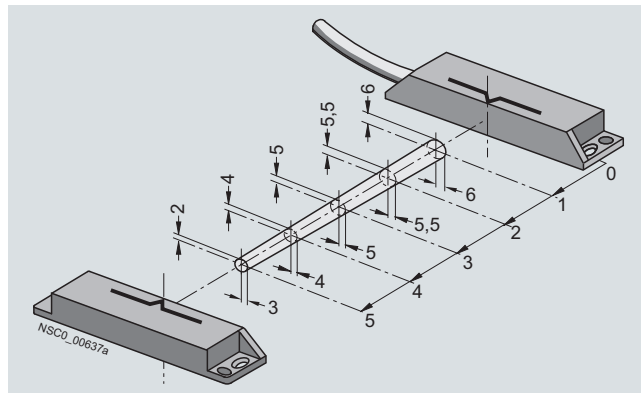

Enabling range (example)

The device has six current-sourcing semiconductor outputs (Y1 ... Y6) which signal the state of the connected protective devices.

The 3SE6 806 safety relay has two floating enabling circuits (safe circuits) as NO contact circuits and one floating signaling circuit as a NC circuit. The number of enabling circuits can be increased by adding one or more 3TK28 30 expansion modules.

Application

SIRIUS 3SE6 magnetically operated switches are designed for mounting on movable protective guards (hoods, hinge switches, doors, etc.). Evaluation can be performed by means of a safety relay or through connection to a bus system.

The 3SE6 6 non-contact, magnetically operated safety switches stand out due to their enclosed design with degree of protection IP67. They are particularly suitable therefore for areas exposed to contamination, cleaning or disinfecting.

A magnetic monitoring system comprises one or more magnetically operated switches and an evaluation unit, e.g. a safety relay. When contact blocks 1 NO + 1 NC are used the 3SE6 806 safety relay provides a high degree of protection against manipulation and can be installed in safety circuits up to Category 3 according to ISO 13849-1 (EN 954-1).

Combination of monitoring units and magnetically operated switches

Monitoring units	Magnetically operated switches (contact block + switching magnet)					Achievable category (EN 954-1)/ Performance level (EN ISO 13849-1)	
	1 NO + 1 NC		2 NC		1 NO + 2 NC		
	3SE6 605-1BA	3SE6 605-2BA	3SE6 605-3BA	3SE6 604-2BA	3SE6 606-3BA		
	3SE6 704-1BA	3SE6 704-2BA	3SE6 704-3BA	3SE6 704-2BA	3SE6 704-3BA		
Relay outputs							
SIRIUS safety relays, 6-fold	3SE6 806-2CD00	✓	✓	✓	--	✓	Cat. 3
SIRIUS safety relays	3TK28 20	--	--	--	✓	--	Cat. 4/e
	3TK28 26	✓	✓	✓	✓	✓	Cat. 4/e
Solid-state outputs							
SIRIUS safety relays	3TK28 40	--	--	--	✓	--	Cat. 3/d
	3TK28 41, 3TK28 42, 3TK28 45	--	--	--	✓	--	Cat. 4/e
SIRIUS safety relays with contactor relay	3TK28 50, 3TK28 51, 3TK28 52	--	--	--	✓	--	Cat. 3/d
	3TK28 53	--	--	--	✓	--	Cat. 4/e
ASIsafe compact safety modules	3RK1 205, 3RK1 405	--	--	--	✓	--	Cat. 4
SIMATIC S7-31xF-2 DP or SIMATIC ET 200M	SM 326 F, 24 DI, 24 V DC, SM 326 F, 8 DI, NAMUR	✓	✓	✓	✓	✓	Cat. 4
SIMATIC ET 200S PROFIsafe	4/8 F-DI / 3 F-DO, 24 V DC	✓	✓	✓	✓	✓	Cat. 3
	4/8 F DI, 24 V DC	✓	✓	✓	✓	✓	Cat. 4
SIMATIC ET 200eco	4/8 F DI, 24 V DC	✓	✓	✓	✓	✓	Cat. 4
SIMATIC ET 200pro	8/16 F-DI, 24 V DC, 4/8 F-DI / 4 F-DO 2 A, 24 V DC, F-Switch	✓	✓	✓	✓	✓	Cat. 4
Modular Safety System	3RK3	✓	✓	✓	✓	✓	Cat. 4/e

✓ Suitable magnetically operated switch

SIRIUS 3SE6 Non-Contact Safety Switches

Magnet

3SE6 6, 3SE6 7 magnetically operated switches

Selection and ordering data

Version	Size	Contacts	DT	Order No.	Price per PU	PU (UNIT, SET, M)	PS*	PG
Round sensor units								
	Switching magnets (coded)	M30	A	3SE6 704-1BA		1	1 unit	41K
	Contact blocks	M30	1 NO + 1 NC A	3SE6 605-1BA		1	1 unit	41K
	• With cable, 3 m	M30	1 NO + 1 NC C	3SE6 605-1BA02		1	1 unit	41K
	• With M12 plug, 4-pole	M30						
Rectangular sensor units								
	Switching magnets (coded)	25 × 88	A	3SE6 704-2BA		1	1 unit	41K
	Contact blocks	25 × 88	1 NO + 1 NC A	3SE6 605-2BA		1	1 unit	41K
	• With cable, 3 m	25 × 88	2 NC A	3SE6 604-2BA		1	1 unit	41K
	• With M8 plug, 4-pole	25 × 88	1 NO + 1 NC C	3SE6 605-2BA01		1	1 unit	41K
			2 NC C	3SE6 604-2BA01		1	1 unit	41K
	Switching magnets (coded)		A	3SE6 704-3BA		1	1 unit	41K
	Contact blocks	25 × 33	1 NO + 1 NC A	3SE6 605-3BA		1	1 unit	41K
	• With cable, 3 m	25 × 33	1 NO + 2 NC B	3SE6 606-3BA		1	1 unit	41K
	• With cable, 1 m	25 × 33						
Accessories								
	Spacers	25 × 88	D	3SX3 260		1	1 unit	41K
	Spacers	25 × 33	D	3SX3 261		1	1 unit	41K
Monitoring units								
	Safety relays with relay output, 6-fold	6	2 NO / 1 NC B	3SE6 806-2CD00		1	1 unit	41K
	Rated control supply voltage 24 V DC							

For more monitoring units see Chapters 2, 8, 9 and 11 as well as Catalog IK PI.

Overview



Non-contact RFID safety switches with maximum tamper resistance

3SE63 RFID contactless safety switches meet the highest safety requirements, SIL3 or Cat. 4, for monitoring the positions of movable protective devices.

An RFID safety switch consists of a coded RFID switch with an 8-pole M12 connector plug and an identical RFID actuator.

The switch is available in several versions:

- Family coded with M12 plug or with additional 18 N magnetic catch as an option
- Individually coded, programmable once, with M12 plug or with additional 18 N magnetic catch as an option
- Individually coded, programmable more than once (an unlimited number of times), with M12 plug or version with additional 18 N magnetic catch

The actuator is therefore available in two versions:

- Standard
- With 18 N magnetic catch

The magnetic catch keeps doors and hinge switches closed with permanent magnets.

Optional accessories

- Covers for sealing mounting holes, also suitable for tamper-proofing screw fixings
- Spacers (approx. 3 mm high) to facilitate cleaning under the installation surface when using pressure washers, for example

Mounting and maintenance

Reduction in the number of versions, because

- switches can be mounted on right or left sides
- the actuator can be mounted on all sides

Quick and easy mounting by thanks to universal mounting holes

- Standard gauge/holes for 3SE6 magnetically operated switch
- Fine adjustment thanks to slotted holes

Little adjustment or maintenance required

- Threshold indication by LED on the switch for quick and easy adjustment during installation and maintenance
- Molded switch allows it to be used as an end stop for small and medium-sized doors

Note:

Keep metal parts and cuttings away from the vicinity of the switch

Minimum distance between two switches 100 mm

Coding

Family coded

These safety switches are delivered ready to use, i.e. no programming is necessary.

Individually coded, programmable once

The assignment of safety switch and actuator thus created is irreversible.

The actuator is programmed simply by routine during startup, thus permanently preventing any form of tampering by means of a replacement actuator.

Individually coded, programmable several times

The procedure for programming a new actuator can be repeated an unlimited number of times. When a new actuator is programmed the previous code becomes invalid. A protected coding process allows new actuators to be programmed for service purposes.

After this, a ten-minute lockout provides enhanced tamper protection. The green LED flashes until the lockout time has ended and the new actuator has been detected. If the operational voltage is interrupted during this time, the ten-minute guard time is restarted.

Programming procedure for individual coding

1. Apply operational voltage to safety sensor
2. Move actuator into detecting range: red LED lights up, yellow LED flashes (1 Hz)
3. After 10 s it changes to a shorter flashing frequency (3 Hz). In this state switch off operational voltage.
4. After the next time the operational voltage is switched on, the actuator is detected again to activate the programmed actuator code. The activated code is thus stored permanently.

Diagnostics

The RFID safety switch indicates its operating state including faults by means of the LED indicator in the switch and the short-circuit resistant diagnostic output. The signals can then be used for central displays or non-safety-related control tasks.

There are two diagnostics functions:

- Crossover monitoring
- Open-circuit monitoring
- External voltage monitoring
- Ambient temperature too high
- Wrong or defective actuator
- Switching interval threshold identification with LED indication

The signal combination "diagnostics output switched off" and "safety outputs still switched on" can be used to move the machine into a controlled stop position.

Any crossover or a fault that is not currently compromising the safe operation of a safety switch results in the disconnection of the safety channels after a 30 minute delay. However, the diagnostics output switches off instantaneously.

SIRIUS 3SE6 Non-Contact Safety Switches

RFID

3SE63 RFID safety switches

Mode of operation of the diagnostics LEDs

The safety switch indicates not only its operating state, but also faults by means of LEDs in three colors at the ends of the RFID switch.

- The green LED indicates readiness for operation when the control supply voltage is connected.
- The yellow LED indicates that there is an actuator in detecting range. If the actuator is in the switching interval threshold, this is indicated by flashing. This flashing can be used to identify a change in the distance between sensor and actuator at an early stage (e.g. as a result of the sagging of a protective door). The installation should be tested before the distance increases further, the safety outputs switch off and the machine stops.
- The red LED indicates the individual causes of the fault by means of defined flashing frequencies.

Benefits

- Maximum tamper resistance by means of individual coding of switches and actuators at the highest safety level
- Plastic enclosure with integrated connector
- 2 electronic short-circuit proof safety outputs, each 250 mA
- Integrated crossover, open circuit and external voltage monitoring, with series circuit as far as the control cabinet
- Safety and diagnostics signals can be connected in series
- Series connection of safety circuits in Cat. 4 / PL e / SIL 3
- LED status indication including switching interval threshold indication for quick and easy adjustment during installation and maintenance
- Short-circuit proof conventional diagnostics output
- Optional version with magnetic catch for interlocking hatches or small doors even when de-energized

- Highly rugged thanks to the use of tested enclosure materials, resistant to aggressive cleaning products, with a degree of protection of up to IP69K
- Fine adjustment thanks to slotted holes
- Little adjustment or maintenance required
- Molded switch allows it to be used as an end stop for small and medium-sized doors

Application

RFID contactless safety switches are designed for use in safety circuits, and are used to monitor the positions of movable protective devices. They monitor the positions of rotating, laterally sliding or removable protective devices using the coded electronic actuator.

Their high degree of protection (IP69K) and the use of cleaning product-resistant materials means that these switches are optimized for use under extreme environmental conditions.

Their electronic operating principle makes these switches ideal for metalworking machinery.

The switches have a larger switching interval and switching displacement than mechanical switches, improve the mounting tolerance of the protective door, and offer a wide range of diagnostics options.

The RFID switches can be connected to all standard evaluation units, e. g. a PLC, 3TK28 safety evaluation units (in which the built-in crossover monitoring function can be deactivated), or the 3RK3 modular safety system.

The following safety categories can be achieved in safety circuits:

- Category 4 according to EN ISO 13849-1 (EN 954-1)
- PL e according to EN ISO 13849-1
- SIL 3 according to IEC 61508

Technical specifications

Type	3SE6 3	
General data		
Standards	IEC 60947-5-3, IEC 61508, EN ISO 13849-1	
Enclosure material	Fiber-glass strengthened thermoplast, self-extinguishing	
Degree of protection	IP69K	
Ambient temperature		
• During operation	°C	-25 ... +70
• During storage, transport	°C	-25 ... +85
Shock resistance	30 g/11 ms	
Vibration resistance	10 ... 55 Hz amplitude 1 mm	
Electrical specifications		
Rated insulation voltage U_i	V	32
Pollution degree acc. to IEC 60664-1	3	
Rated impulse withstand voltage U_{imp}	V	800
Rated conditional short-circuit current	A	100
Rated operational voltage U_e (PELV acc. to IEC 60204-1)	V DC	24 -15/+10 %
Protection class	II	
Overvoltage category	III	
Rated operational current I_e	A	0.6
Smallest operational current I_m	mA	0.5
No-load supply current I_0	mA	35

Type	3SE6 3	
Inputs/outputs		
Safety inputs X1/X2		
• Input voltage	V DC	24 -15/+10 %
• Power consumption per input	mA	5
Safety outputs OSSD1/OSSD2		
p operation		
• Max. rated operational current I_e	A	0.25
• Rated operational current $I_e/DC-12/DC-13$ at U_e	A	0.25
• Voltage drop U_e	V	< 1
• Switching frequency	Hz	1
• Response time, max.	ms	100
• Risk time, max.	ms	200
• Recovery, max.	s	5
Diagnostics output		
p operation		
• Max. rated operational current I_{e2max}	A	0.05
• Rated operational current $I_e/DC-12/DC-13$ at U_e	A	0.05
• Voltage drop U_e	V	< 2
• Operational current	mA	150
• Conductor capacity, max.	nF	50

3SE63 RFID safety switches

Directions of approach and switching interval

The side area permits a maximum height offset of the switch and actuator of ± 8 mm (e.g. mounting tolerance or due to sagging of the protective door). The transverse offset also equals max. ± 8 mm.

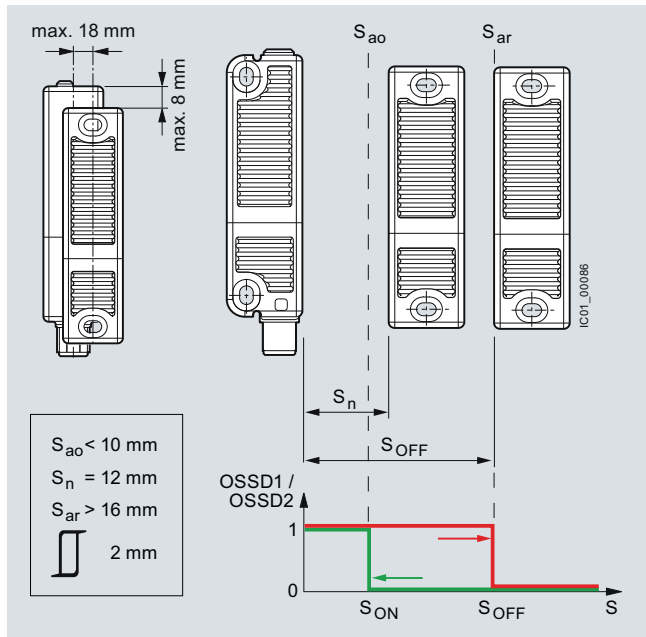

Switching interval: output signal with hysteresis

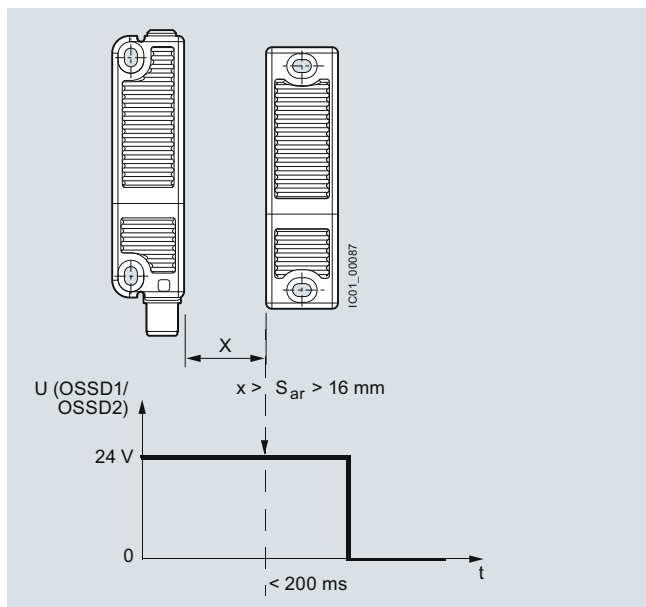

Switching interval: Output signal

Connector assignment

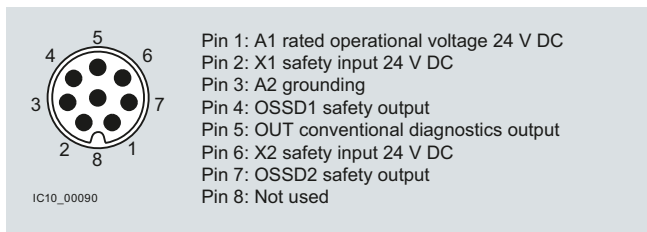

Dimensional drawings

RFID switches 3SE6 315

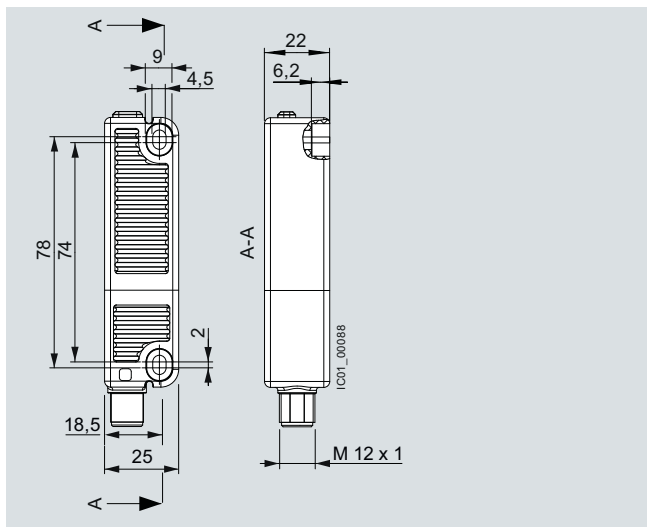

RFID actuator 3SE6 310

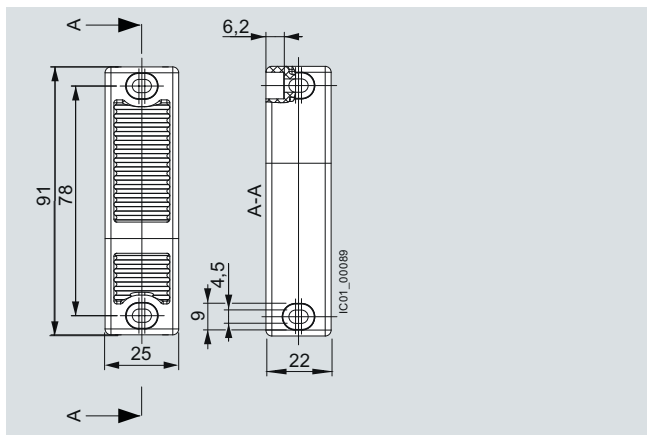





SIRIUS 3SE6 Non-Contact Safety Switches

RFID

3SE63 RFID safety switches

Selection and ordering data

With M12 connector, 8-pole

Version/coding	Latching / length	DT	Order No.	Price per PU	PU (UNIT, SET, M)	PS*	PG
Rectangular safety switches 91 mm x 25 mm							
RFID safety switches							
	• Family coded	None	A	3SE6 315-0BB01	1	1 unit	41K
		With 18 N magnetic catch	A	3SE6 315-1BB01	1	1 unit	41K
	• Individually coded, programmable several times	None	A	3SE6 315-0BB02	1	1 unit	41K
		With 18 N magnetic catch	A	3SE6 315-1BB02	1	1 unit	41K
	• Individually coded, programmable once	None	A	3SE6 315-0BB03	1	1 unit	41K
		With 18 N magnetic catch	A	3SE6 315-1BB03	1	1 unit	41K
RFID actuators							
	• Standard	None	A	3SE6 310-0BC01	1	1 unit	41K
		With 18 N magnetic catch	A	3SE6 310-1BC01	1	1 unit	41K
Optional accessories							
Covers and spacers							
	One pack (1 unit) contains 8 covers and 4 spacers		A	3SX5 600-1G	1	1 unit	41K
Connecting cables, 8-pole, with 1 straight M12 socket							
	Length 3 m		A	3SX5 601-2GA03	1	1 unit	41K
	Length 5 m		A	3SX5 601-2GA05	1	1 unit	41K
	Length 10 m		A	3SX5 601-2GA10	1	1 unit	41K
Rated voltage 30 V							
Rated current 2 A							

3SE6 315

3SE6 310

3SX5 600-1G

3SX5 601-2GA

For monitoring units see Chapter 2, "Industrial Communication" → "AS-Interface" and Chapter 11, "Safety Technology" as well as Catalogs IK PI and ST 70.